



NorthStar Outdoor Series Owner's Manual

NS 46, NS 56, NS 57 with SL2 Control and CB 16-1 and Bluetooth Sound Sytem (Optional)



NS 57 Room (5' x 7')

NS 46, NS 56 Room
(4' x 6', 5' x 6')

Precautions Before Use	2
Read Before Installation	2
Exterior Paint Requirements	3
Room Summary	4
Room Assembly	5
Roof Assembly	10
Electrical Installation	14
Sound Bar Installation	18
Interior Installation	20
Control Operation	22
Maintenance and Troubleshooting	24



Read all instructions carefully before installation including instructions packaged separately with the sauna heater. Please leave all instructions and warranty with the owner.

WARNING: When using electrical sauna heaters and associated sauna products, basic precautions must be followed, including the following:

1. Grounding is required.
2. No electrical receptacle shall be installed in the sauna room.
3. Be sure rocks are placed in the heater according to the Heater Installation and Operation Instructions.
4. Do not tamper with the door or install a latching or locking system. Malfunction of which may cause entrapment inside the heated room.
5. Do not block ventilation openings. Vents must be kept free of obstruction so proper airflow is maintained in the sauna room. Do not stack anything in front of the vents.

WARNING: Prolonged exposure to elevated temperatures is capable of inducing hyperthermia. Hyperthermia occurs when the internal temperature of the body reaches several degrees above the normal body temperature of 98.6°F. The symptoms of hyperthermia include an increase in the normal temperature of the body, dizziness, lethargy, drowsiness, and fainting. The effects of the hyperthermia include failure to perceive heat, failure to recognize the need to exit the room, unawareness of impending hazard, fetal damage in pregnant women, physical inability to exit the room and unconsciousness.

WARNING: The use of alcohol, drugs, or medication is capable of greatly increasing the risk of fatal hyperthermia.

CAUTION FIRE HAZARD: Do not use the sauna room for drying clothes, bathing suits, etc. Do not hang towels above the heater or place any object, other than the rocks supplied, in the heater. If any darkening of the wall around the heater is noticed, discontinue sauna use immediately.

ROOM ASSEMBLY

- Each panel is heavy. Be careful to avoid injury when installing, especially the roof panels.
- Two adults are required for the installation of sauna room.
- The wall panels are connected with tongue and groove slots which will be installed in the following way:
 - When setting panels, ensure the tongue lines up into the groove.
 - Secure wall panels together with a screw on top of the wall.
 - Connect corners of wall panels with screws in the side wall.



WARNING!

The raw wood exterior of this sauna MUST be sealed with an approved exterior coating immediately! Exposure to rain in the “raw” state can permanently damage the wood and void your warranty!

4126-126

Rev A

NorthStar Outdoor Sauna					
Wood Species	Product	Brand	Water vs. Oil	Supplier	Additional Comments
Nordic White Spruce	Paint	Duration	Water based	Sherwin Williams	Self-Priming
		Emerald	Water based	Sherwin Williams	Self-Priming
		Pittsburgh Paramount *	Water based	Various	Self-Priming
	Stain	Storm	Oil based	Hirshfield’s	Requires “storm” primer. Variations of tones/colors
		Sikkens Cetol Log and Siding	Oil based	Various	Transparent



Tip: Paint/Stain exterior cove trim prior to installation for ease in painting.

* Photo above used paint: Pittsburg Paramount Exterior Paint.

Note: A natural characteristic of wood is to shrink over time. You may need to apply a second coat of paint or sealer.

Trim Profiles

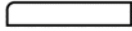

Window/Door Casing (normally pre-installed)



Inside Cove Molding

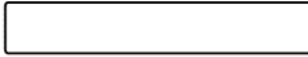

Exterior Fascia Trim



Eve Trim / Exterior Cove Molding

Hardware Package



Carriage Bolts, Washers, & Nuts (for saunas with L-benches)



9 x 2 Wood Screw

9 x 3 Wood Screw

Torx Bit

Description	Location	Quantity
2" Torq Wood Screws		9
3" Torq Wood Screws	Various	9
5" Torq Wood Screws	Ceiling to Walls	18
Torq Bit (T25)	Various	1
Sheet Metal Roofing Screws	Roofing	40
Carriage Bolt & Washer	NS 57 Bench ONLY	2

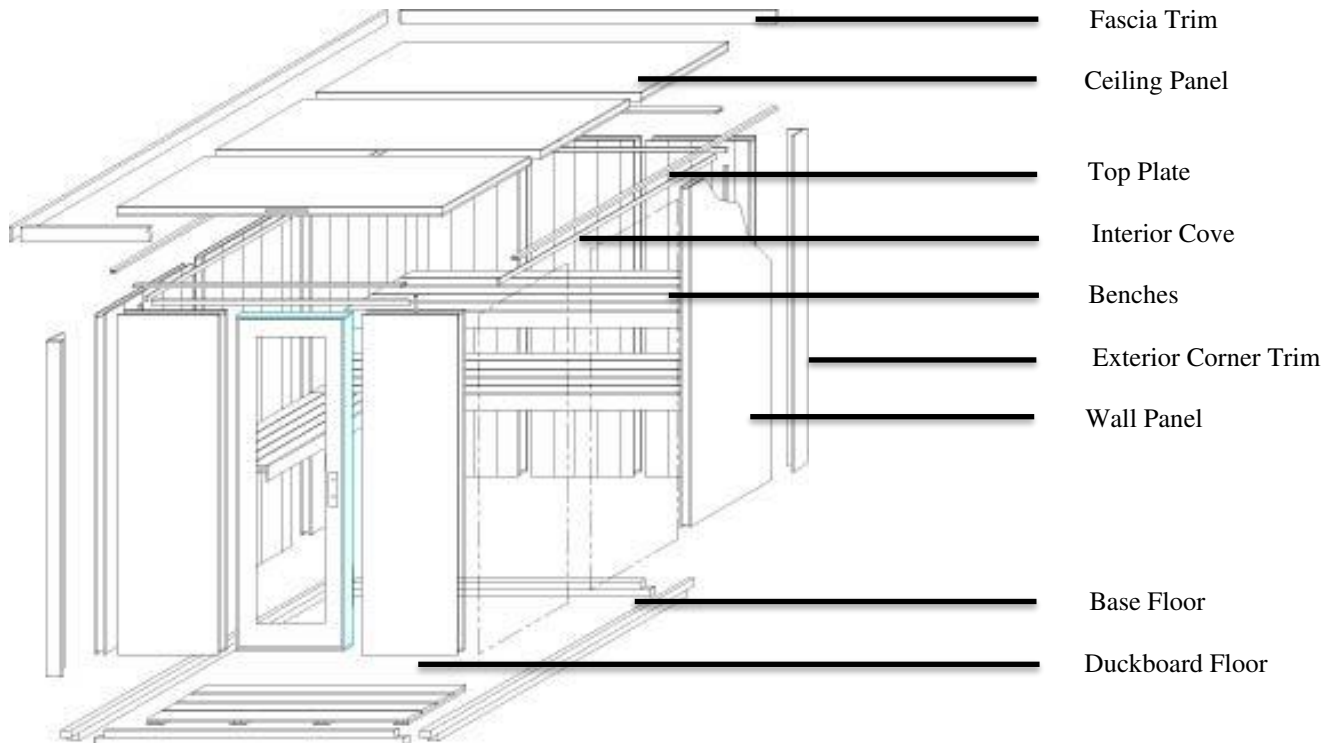

Note: Parts depicted in the diagram will differ between models.

INSTALLATION OF SAUNA ROOM

1. Place the floor panel in the desired location on a level surface

Note: The floor panel must be level before installing wall and roof panels. If the surface is not level, you may need to shim the floor panel to get it level.

The base is numbered to correspond with the panels for correct locations. The front right wall panel is labeled # 1, the front panel of the right side wall is labeled #2 and etc...(See picture below)

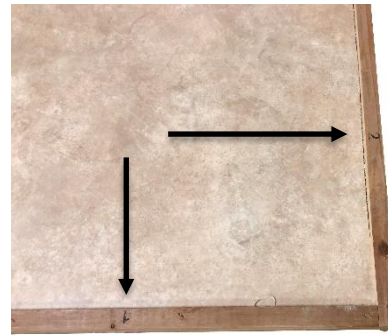

2. Place the front right corner wall panel (panel 1) on the outer edge of the corresponding floor panel.
3. Place the front panel of the right wall (panel 2) on the floor and butt it to the front panel.

Note: The 4 x 6 and 5 x 6 rooms have a one-piece side wall system, and the 5 x 7 rooms have a two-piece side wall system. The two-piece system is shown, but the process is the same for the one-piece system.



4. Secure the right wall to the front wall with three 3" Torq screws (provided). Install one screw on the top of the wall, one in the middle, and one on the bottom. Ensure the tongue and groove wall boards are tight together at the interior corner of the sauna and the corner is flush on the outside edge when screws are installed.



5. Install the next wall panel of the right wall. Ensure the tongue and groove are fully engaged between panels.



6. Secure the two wall panels together with a 3" screw where the panels meet on top. Ensure tongue and groove are fully engaged.



7. Install the next panel in the number series. Secure the side wall to the back wall panel with three 3" Torq screws. Ensure the tongue and groove are tight at the interior corner when screws are installed.



8. Install the second and third panels of the back wall. Repeat step 6 between each back panel.

9. Install the next panel in the number series. Secure to the back wall with three 3” Torq screws. Ensure the tongue and groove are tight at the interior corner when screws are installed.



10. Install the next wall panel of the left wall. Repeat step 6 between the wall panels.



11. Install the door panel next to the right front wall panel. Repeat step 6 between wall panels.

12. Install the remaining wall panel to the door panel. Repeat step 6 between wall panels.



13. Secure left front wall panel to the left side wall with three 3” Torq screws. Ensure the tongue and groove are tight at the interior corner when screws are installed.

14. Install top plates to the corresponding wall panels on front and back sides with the notched ends facing up. Install the left and right-side top plates so they fit into the notches.



Note: Before installing top plate, ensure all panels are connected together on top and on the corners.



15. Secure top plates using the 2" Torq screws. Install one screw in each corner and one screw in the center of each wall.

16. Install corner caps to each corresponding wall panel using Brad nails or finishing nails (not supplied).

Note: Some woods will twist, which is normal, so the installation can be more difficult. See end of manual for suggestions on how to install a twisted corner cap.

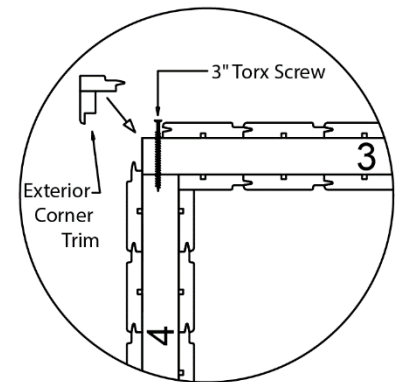

17. Install the lower bench supports to the right and left side walls between pencil marks on red sticker labeled “Lower Bench Support”. Secure with 3” Torq screws in the provided predrilled holes.



18. Install a 3” Torq screw into each access opening to secure the walls to the base plate and floor.

19. Install an access board into each opening. Secure with Brad nails.



INSTALLATION OF ROOF

Note: The 4 x 6 and 5 x 6 rooms have a two-panel roof system and the 5 x 7 room has a three-panel roof system. The two-panel system is shown below, but the process is the same for the three-panel system.

20. Place the right roof panel on the room. The guide strip will align the panel on the front wall until final placement is set and secured.



Note: Ensure the roof panel is aligned to the exterior of the front wall panel using the guide strip.



Guide Strip

21. Repeat 20 for the left roof panel (left and center panels of NS 57).

Note: Ensure tongue is fully engaged in groove of roof panel.

22. Secure roof panels together using a 3" Torq screw.



23. Once roof panels are secured together to create one piece, center the roof over the room. The left overhang should be equal to the right overhang. Check three points on each side to ensure the distances are equal.

24. Using the 5-1/2" Torq screws, go through the roof panel to secure to the top of the walls. Secure the roof panel at the front of the sauna and ensure the side overhang in the back of the sauna is the same as the front. Secure roof to back wall and then side walls.

How to find location of center of walls: Measure the overhang from the wall to the edge of the roof panel and add 1 1/2" to find center of the wall. Repeat for all four edges.

25. Once the roof panels are secured, remove the guide strips.

26. Nail fascia trim to the exterior edge of roof starting with the back edge. Next the two side edges, and lastly the front edge. The fascia top should be flush with the top of the roof panel.

Note: Trim is sent long to be cut on site for proper fit.

Note: Back fascia is equal to the back roof length.

Side fascia is equal to the side roof length plus back fascia. Side fascia is cut at a 5 degree angle.

Front fascia is equal to the front roof length plus both side fascia.



27. Install eve trim under the overhanging fascia starting with the back edge. The back trim should be cut so it is flush to the left and right-side fascia.

Note: Nail trim into ceiling so the flat edges are against the fascia.

28. Install the front side eve trim so it is flush to the left and right-side fascia.



29. Install the left and right-side eve trim so it is flush to the back side trim and front side trim.

30. Install exterior cove to the back wall so it is flush to the left and right edges of the wall.

Note: Nail cove into wall so the flat edges of the cove lie flush to the ceiling and wall.

31. Install exterior cove to left and right-side walls so it is flush to back side cove and the edge of the front wall.
32. Install exterior cove to front wall so it lays flush to left and right-side cove.



33. Cut metal drip edge to the length of the roof and install to the back side of roof so the side with three grooves is on top of roof . Secure to roof with roofing nails or staples (not supplied).



34. Install the roofing felt on the roof panel using a stapler to prevent moisture from getting on the wood. Start from the back of the room, working towards the front. Overlap the paper a minimum of 2” to ensure moisture does not get under the paper. Trim tar paper to be flush with the edges of the roof panels.

35. Lay out the metal roofing sheets on a flat surface to determine the amount of overlap needed to match the width of the roof.

Note: The flat edge of the metal sheet should always be on top.



36. Install roofing, starting from the left side of the room. The edge of the first sheet should be flush with the left edge of the roof panel and the drip edge. Secure sheets with roofing screws at the top edge (front of room).

37. Insert foam between metal roofing and drip edge to prevent insects from getting under roofing.



38. Secure metal roofing with one row of screws at the back of roof at every other rib and another row of screws across the middle of roof at every other rib.

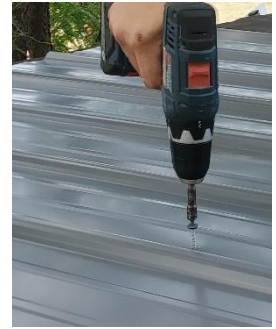

39. Mark and cut the left and right-side flashing so it is flush with front edge of roof.

40. Secure left and right-side flashing to fascia with three roofing screws.



41. Install front flashing to the roof so there is $\frac{1}{4}$ " of overhang on each side. Secure on top with 4 roofing screws, one 5-1/2" from each edge and the remaining two centered in between. Secure to fascia with 4 roofing screws.



Note: Predrilling the metal with a $\frac{1}{8}$ " drill bit is suggested for ease in installation.

42. Before screwing down the front flashing, insert the seal on top of roofing metal and underneath the front flashing.

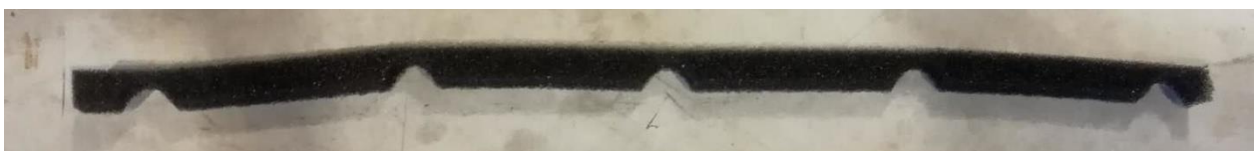

ELECTRICAL / HEATER ASSEMBLY

43. Place CB Box on the floor for easy access. Remove the cover to access the electrical connections.

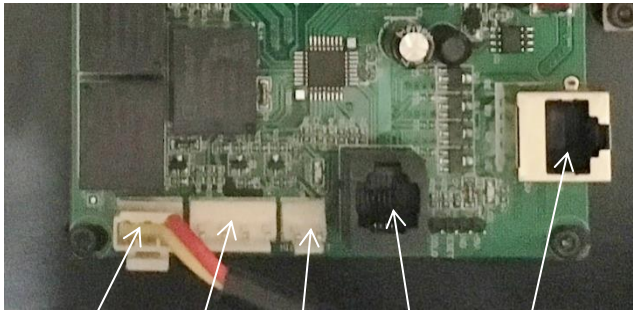

44. Connect all the quick connections into the CB Box according to the picture and installation manual.

Note: All the low voltage connections have unique connectors.

- 1- Bluetooth Power (3 pin from Bluetooth sound bar (optional))
- 2- Room Temp Sensor (4 pin from wall)
- 3- High Limit (2 pin from heater)
- 4- Control (RJ 11 from wall)
- 5- Lights (RJ 45 from wall)

45. Install power cable (provided) to the sauna heater.

46. Lay the heater on its back and remove the two #8 screws that secure the bottom cover plate (save screws for re-installation).



47. Install the strain relief clamp as shown, about 2.5" from the end of the black rubber insulation. Remove the retaining nut for later installation in heater. Tighten the two clamp screws securely so the strain relief does not slide on the cable.



48. Insert the cable into the open hole on the back of the electrical enclosure and secure using the retaining nut from the first step. Tighten nut to prevent the strain relief from moving.

49. Insert the black, white, and green wires into the terminal block as shown. Tighten the screws securely (approximately 18 in/lbs.)

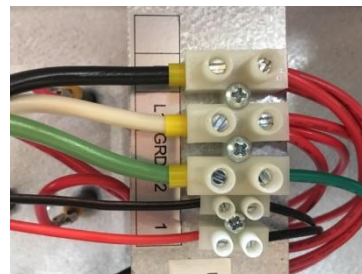

Green = ground
Black = L1 (hot)
White = L2 (hot)



50. Determine power requirements and wire size needed based on the room model.

Room	Sauna Heater	kW	Phase	VAC	Sauna Amps	WIRE SIZE	
						Power Supply to CB 16-1	CB 16-1 to Traditional Heater
NS 46	Viki 4.5	4.5	1	240	18.8	2 #10AWG + GR	2 #10AWG + GR
NS 56	Viki 6.0	6.0	1	240	25.0	2 #10AWG + GR	2 #10AWG + GR
NS 57	Viki 6.0	6.0 <td>1</td> <td>240</td> <td>25.0</td> <td>2 #10AWG + GR</td> <td>2 #10AWG + GR</td>	1	240	25.0	2 #10AWG + GR	2 #10AWG + GR

NOTE: All installation and service to this equipment should be performed by qualified licensed personnel in accordance with local and national codes.

NOTE: A GFCI (Ground Fault Interrupt Circuit) device is not required by NEC. A GFCI may be installed if required by local codes but will nuisance trip during use of the product.

CAUTION: Loose wire connections can cause heat damage to wires, terminal blocks and other components and may void the warranty.

51. Connect wires from building electrical supply to the lower terminal block labeled L1, L2, and Gnd. (Building wire is not supplied)
52. Connect wires from the heater to upper terminal block labeled T1, T2, and Gnd to the sauna heater.



 **WARNING:** Final input power should be performed by a qualified electrician.



53. Install the CB-16-1 Contactor box to the back wall. Use the two spacing blocks provided as a guide to find the lower left corner of the box to wood corner trim on wall.

Note: If the mounting holes of CB box line up with a groove in the wall, move the box left or right so they line up on a solid portion of the tongue and groove.

54. Mount the CB Box to the back wall with the four screws provided in the hardware pack, inside the CB box.
55. After all connections are complete, place cover on CB Box with the four screws provided.



56. Install plastic wire raceway on right side wall. Peel adhesive strip off the back side of raceway and attach to the wall, flush with the floor and about 12” from the front of the room. Make sure the open slot is facing up so wires can be inserted.

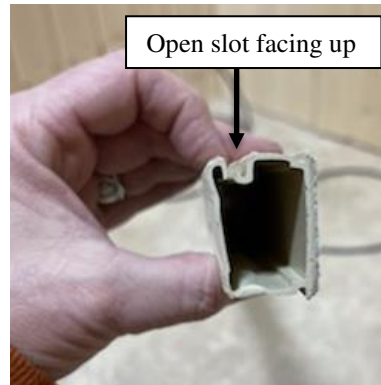

57. Insert the large black main power cable into the open slot of the wire raceway.



58. Insert the sensor and control cables into wire raceway, one cable at a time, and orientate them so they are on top of the large power cable and positioned towards the back of the raceway.

59. When all the cables are in the raceway, seal the raceway shut by starting at one end and snapping the “cover” shut as you move towards the opposite end. If the cover will not close you may need to re-orientate the wires.



60. Connect the control wire from the front wall to the control.



61. Use a flat-blade screwdriver to carefully pry the front glass off the control body.



Install two of the shorter screws to the control. Place a black plastic wing on the end of each screw longer screws are not used).

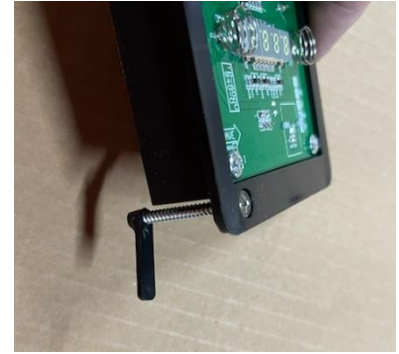

62. Mount control on to wall so the wires are inside the wall. Secure control to wall with the previously installed screws and wings. Place glass cover on control.

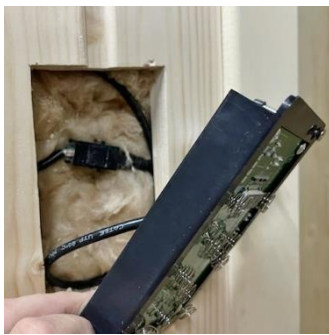

63. Hang heater on front wall. Use the mounting template included inside the heater shipping box to correctly pre-drill the 4 mounting holes.

64. Assemble wood heater guard before installation using the screws and wooden caps provided. Use the two spacing blocks as a guide for installation. Place one block horizontally on the floor and the other stacked vertically on top. Install the wood heater guard around the sauna heater using the 1 1/8" screws provided.



65. Temporarily connect the backrest lights to the back wall.

66. Ensure all electrical connections are installed and everything is safe.

67. Apply power to the heater. The control will flash for about 15 seconds as it is booting up.

68. Press the room light button to ensure backrest lights turn on.

69. Press the On button and allow heater to run for 15 seconds, then turn off.

70. Put your hands close to the elements (DO NOT TOUCH) to feel if all three elements are heating. Or, have the electrician verify the correct Amp draw for your heater.

71. Confirm everything is working. After confirmation, do the final installation of the control and install rocks in the heater.

User and installation manual for SL2 Sound Bar (Optional)

This Bluetooth Audio system has been designed exclusively for use with the SL2 and SL2-C sauna control systems. Do not attempt to connect to any other control system. Record the product serial number, found on the back of the sound bar in the space designated on the back of this document and save for future reference.

Mounting SL2 Sound Bar

- It is recommended that you mount the sound bar off the sauna floor. Attach the wooden cleat as shown in Diagram B with the bevel facing up, using the 2" Torx bit screws. The best sound will be achieved if the sound bar is mounted in the center of the back wall. You may want to experiment with locations before securing the wall cleat.

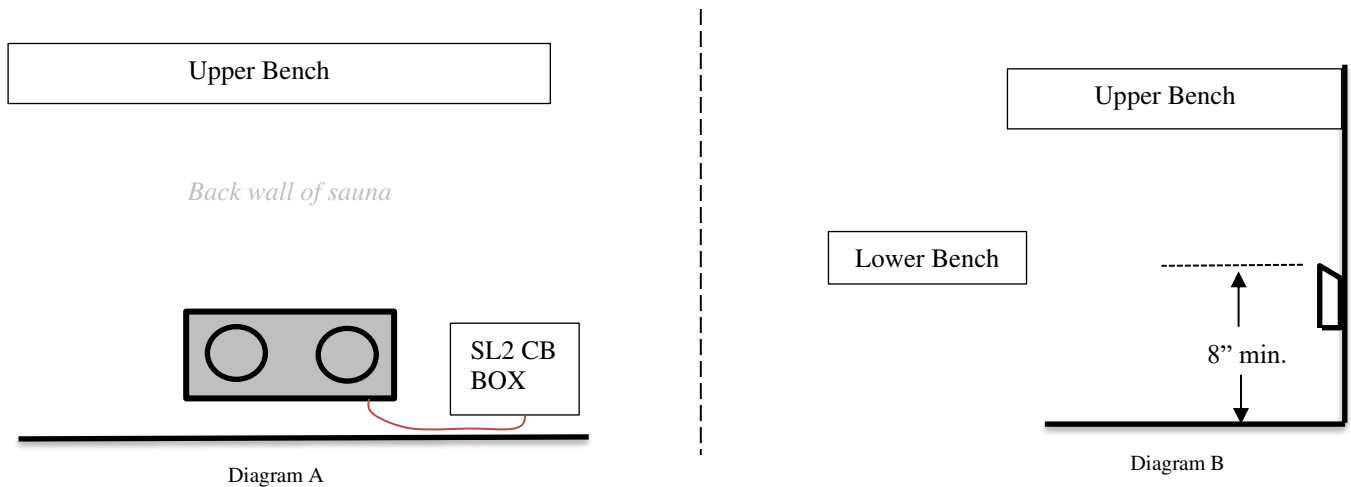

- Hang the SL2 sound bar on the wall cleat. (Mating cleat is located on the back of the sound bar.)

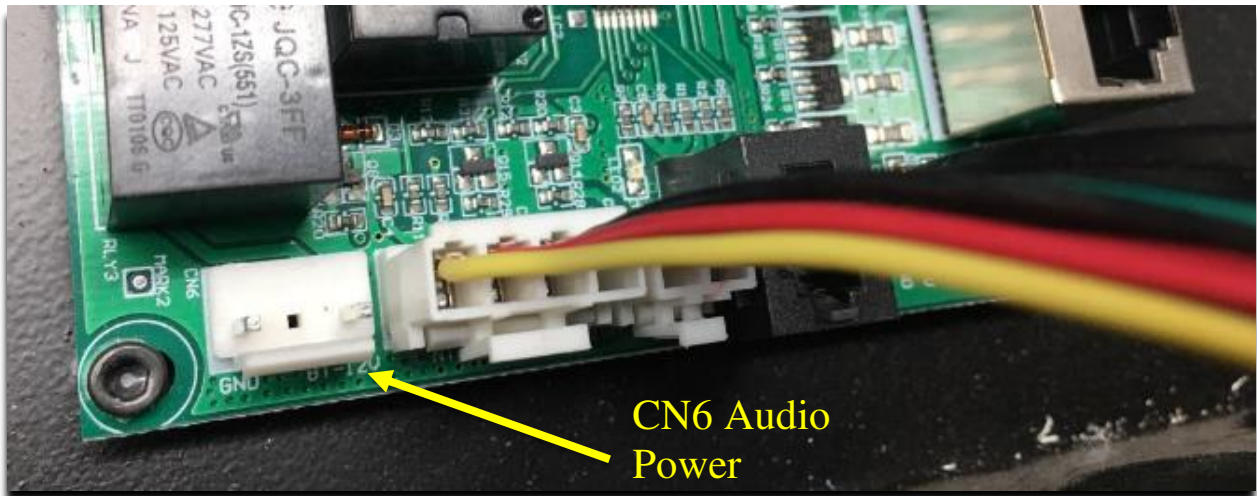

- Connect the sound bar power cord to the "CN6" port, located inside the SL2 or SL2-C contactor box.

Using your SL2 Sound Bar

- Touch the Bluetooth button on your SL2 or SL2-C control to activate power to the SL2 Sound Bar.
 - A confirmation tone will be heard on your sound bar speakers when power is applied.

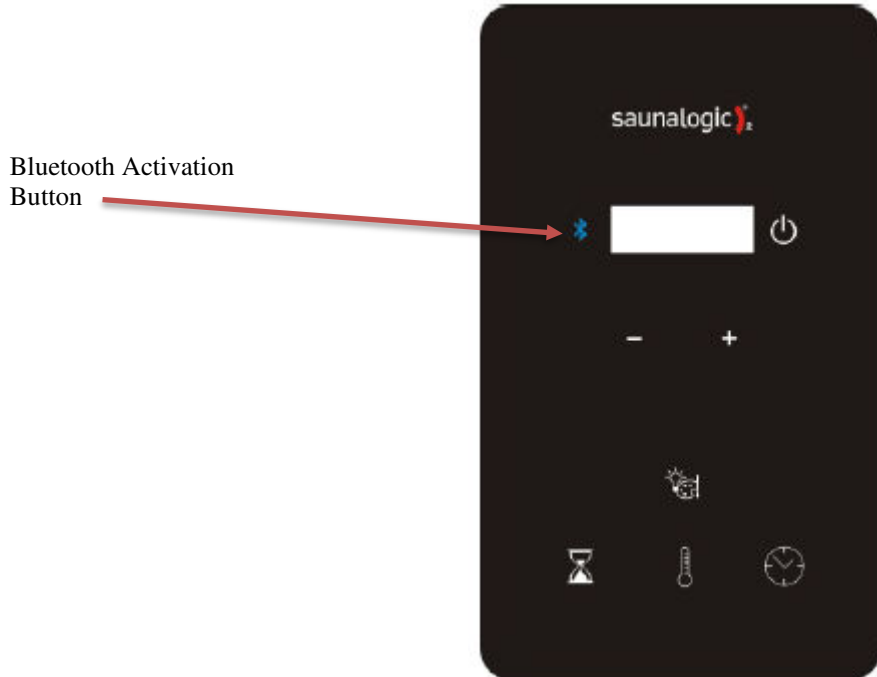

- Locate “Bluetooth” in your smart device settings. Find and select “**TyloHelo Audio**”.
 - You will hear a confirmation beep when pairing is complete.
- Open your favorite music source App and use the volume keys on your smart device to adjust volume on the SL2 Sound Bar. All control functions are through your smart device and music App.

WARRANTY

TyloHelo Inc. will warranty the SL2 Sound Bar for a period of one (1) year from date of purchase. Warranty may include repair or replacement of any/all components, at TyloHelo’s discretion.

Contact TyloHelo Technical Support Team for questions regarding the use of the SL2 Sound Bar or to file a warranty claim. 1-800-363-0251 or at techsupport@tyloheloinc.com

Date of Purchase: _____

Place of Purchase: _____

Record Serial Number Here

INTERIOR INSTALLATION

72. Install interior cove to front wall so it is flush to left and right edges of the wall.

73. Install cove to left and right side walls so it is flush to front cove and back wall.

74. Install cove to back wall so it is flush to left and right side cove.



75. Install door handle so the handle with the predrilled holes is inside the room. Secure handle with two screws provided within the handle package and cover screw heads with wooden buttons.



The NS 46 and NS 56 bench systems have two benches which span from left to right walls.

76. Place upper bench on the upper bench supports. Rest the bench upward for easier installation of the lower bench.



77. Place lower bench on the lower bench supports. Lower upper bench into place.

78. Secure upper bench with two 3” screws through the framework into the backwall and one 3” screw into right and left sidewalls.



Note: Do not secure the lower bench, as it is designed to slide back out of the way for ease of cleaning.

The NS 57 bench system has three benches (Upper Main Bench, Upper Return Bench, Lower Main Bench). The upper main bench and lower main bench span from left to right walls. The upper return bench butts up to the upper main bench and spans to the front wall.

Place upper main bench on upper bench supports. Rest bench upwards.



79. Place lower main bench on lower bench supports. Lower upper bench into place.

80. Install upper return bench to the notch on the upper main bench and the front wall bench support. Use the 3/8" bit to drill 2 holes where the upper main and upper return benches meet. Bolt the benches together using the carriage bolts provided.

Note: When aligning the return bench with the main upper bench, make sure the bench tops are flush with each other.



81. Place duckboard (floorboard) on floor in front of the lower bench.



82. Connect the wires from the back of the backrest to the wires from the back wall. Install the backrest to the back wall through the predrilled holes (standard height is 20" from top of bench to the top of the backrest). Install wooden caps over screws.



SL2 (SaunaLogic 2) Control Operation

Operating Instructions for Heater

Default settings for temperature are preset to 194°F, the bath time is set to 60 minutes and 0-minute delay to start to heat. These settings are adjustable (as described below) from 119°F to 194°F. Length of sauna can be set from 0 to 60 minutes. The time delay before start can be up to 24 hours. Any changes are remembered by the heater for your next bath. Should the heater power be lost then restored, the settings will return to their default values.

STARTING SAUNA HEATER IMMEDIATELY

Press the control POWER  icon to turn on the sauna control and heater. The room temperature will be displayed on the control. The heater will turn on and begin heating the room to current set points. Once the set temperature is reached inside the room, the control will turn the heater on and off again as needed to maintain the desired temperature. At the end of the selected time (60 minutes maximum), the control will turn itself off and the control display will turn off.



SETTING THE TIME AND TEMPERATURE

To set the sauna length time, press the  icon and then press the "+" or "-" icons to increase or decrease time for desired setting. The maximum of time is 60 minutes.



To set the temperature, press the  and next "+" or "-" icons to increase or decrease temperature for desired setting. The maximum temperature is 194°F (90°C).

Note: Typical sauna bathing set-point temperature is 150°F to 165°F on the control.

PRE-SET DELAYED START

Press the  icon and delay time will appear in the display and will toggle between "dlay" the amount of time remaining. The maximum of time is 24 hours. If no delay is desired, press  icon to toggle off the function.

Operating Instructions for Lighting

Press  icon to cycle through lighting options. Press and hold the  icon for 3 seconds to turn off the lights. Lights will turn off automatically 10 minutes after sauna cycle is completed.

- Color sequence – White – Red – Green – Blue – Yellow – Aqua – Purple – Rotation of Colors – Off

Choose the color of choice and then set lighting brightness. The brightness will be on display for 3 seconds. Press the "+" or "-" icon to increase or decrease the light setting. Setting options are 25, 50, 75, and 100% light output.

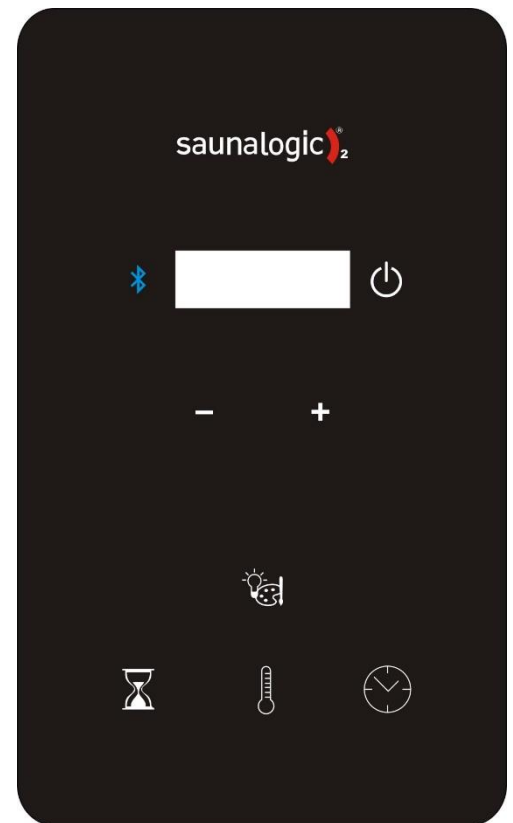

AUDIO OPERATION

Audio Power On

- Press  icon to toggle On or Off the Bluetooth System.

Note: The control does not have to be active for Sound System to operate.

Pairing

- Refer to your mobile device to pair to the unit.
- The Room device name is TyloHelo Audio

Operation

- All operations are controlled by the mobile device
- Volume is controlled by the mobile device

WARNING

Apple will not warranty your Apple product if used at operating temperatures of 32°F or below and 95°F and above. The recommended operating temperature is 32°F to 95°F to fall into the warranty. Check with any other device manufactures for operation temperatures before using the device in the Sauna/IR Room.

USER MAINTENANCE INSTRUCTIONS



WARNING!

The exterior of your NorthStar outdoor sauna requires prime/paint or stain within a few days of installation, and before being exposed to rain/snow. DO NOT paint or stain the interior. See page 3 for recommendations.

Room Instructions for Cleaning:

Perspiration and dirt may absorb into the wood, so periodic cleaning is needed. Scrubbing the benches and floorboards with a stiff brush and mild detergent is normally sufficient. Light sanding is another option.

Room Assembly Questions

If corner cap wood is twisted, nail it into the wall panel to secure to room. If it is twisted at the top, start nailing at the bottom and work up as another person is holding the corner cap firm against the wall panel. If it is twisted at the bottom, start nailing at the top and work down.

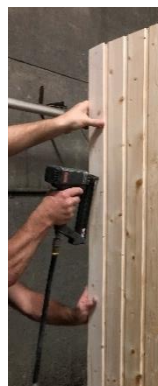

Trim the excess nail off the corner cap. Apply wood filler to repair spots. Sand clean so you don't see the nail heads.



TROUBLESHOOTING

Error Codes on SL2 Control

Sn = Means the sensor is not connected to the CB box. Check the connections between sensor and box

HL = Means the Hight Limit switch in sauna heater is not connected to the CB box. Check the connections between heater and box.

JP = Means a jumper CN 6 is missing from the Main PCA in CB box.

Pre-Heat = Means there is no sensor connected to the CB or the temperature is below 8°F.

Prior to calling, please have the Model, Type Number, and Serial Number from room available.

If you have any questions during the installation of your sauna, please contact your local dealer or our tech support team.

Toll Free: 1-888-780-4427

E-mail: techsupport@tyloheloinc.com

Date of Purchase: _____ Place of Purchase: _____

Record Serial Number Here

Enjoy Your Sauna!

Follow Finnleo (@finnleosauna) on social media. Tag Finnleo & include #MyFinnleo for a chance to be featured on our page.



www.finnleo.com •

575 East Cokato St., Cokato, MN 55321

