

SPA OWNER'S MANUAL



IMPORTANT SAFETY INSTRUCTIONS

**READ & FOLLOW ALL INSTRUCTIONS
SAVE THESE INSTRUCTIONS**



OM-BESTLIFE-23G

INDEX

Contents

INDEX.....	1
BRAND CONFIGURATION TABLE.....	3
SAFETY SIGN	4
CONDITIONS OF WARRANTY AND CONSUMER OBLIGATIONS.....	5
YOUR PERSONAL SPA DATA.....	6
IMPORTANT SAFETY INSTRUCTIONS	7
INSTALLATION INSTRUCTIONS.....	9
ELECTRICAL CONNECTION GENERAL INFORMATION	11
NORTH AMERICAN (60HZ) MODELS	11
EUROPEAN (50HZ) MODELS	14
TYPICAL RESIDUAL CURRENT DETECTOR (RCD).....	15
230 VOLT SUPPLY CONNECTION.....	15
CONVERSION FROM SINGLE SERVICE TO 3-SERVICE	17
WHAT'S INSIDE YOUR SPA.....	18
WHAT'S UNDER YOUR SPA (THE EQUIPMENT)	22
START-UP	23
M8 TECHNOLOGY	25
TP500S CONTROL PANEL USER GUIDE	26
SPATOUCH 3 ICON DRIVEN USER GUIDE	52
BLUETOOTH AUDIO SYSTEM	80
THRU WALL SKIMMER.....	81
ACCESSING FILTER CARTRIDGES	82
MAINTENANCE	83
FILTER SYSTEM.....	85
DRAINING YOUR SPA	86
WINTERIZING YOUR SPA.....	87
TROUBLESHOOTING YOUR SPA.....	88
WATER TREATMENT GUIDE.....	95

BRAND CONFIGURATION TABLE

Line	Model	Frame/Bottom	Filter	Keypad User Guide
BestLife	M33L	Polysteel/Tray	75 Sq. Ft. Top Load Pressure	TP500S
	M38S	Polysteel/Tray	75 Sq. Ft. Top Load Pressure	TP500S
	M41L	Polysteel/Tray	75 Sq. Ft. Top Load Pressure	SpaTouch 3
	M49S	Polysteel/Tray	75 Sq. Ft. Top Load Pressure	SpaTouch 3
	F41S	Polysteel/Tray	75 Sq. Ft. Top Load Pressure	TP500S
	F50S	Polysteel/Tray	75 Sq. Ft. Top Load Pressure	SpaTouch 3
	F41L	Polysteel/Tray	75 Sq. Ft. Top Load Pressure	TP500S
	F50L	Polysteel/Tray	75 Sq. Ft. Top Load Pressure	SpaTouch 3
	F54B	Polysteel/Tray	75 Sq. Ft. Top Load Pressure	TP500S
	F65B	Polysteel/Tray	75 Sq. Ft. Top Load Pressure	SpaTouch 3
	G49L	Polysteel/Tray	75 Sq. Ft. Top Load Pressure	TP500S
	G64L	Polysteel/Tray	75 Sq. Ft. Top Load Pressure	SpaTouch 3
	G55S	Polysteel/Tray	75 Sq. Ft. Top Load Pressure	TP500S
	G74S	Polysteel/Tray	75 Sq. Ft. Top Load Pressure	SpaTouch 3
	G66B	Polysteel/Tray	75 Sq. Ft. Top Load Pressure	TP500S
G81B	Polysteel/Tray	75 Sq. Ft. Top Load Pressure	SpaTouch 3	

CONGRATULATIONS ON THE PURCHASE OF YOUR NEW SPA

We have tried to compile a complete, easy to understand manual all about your spa and its' maintenance. Years of research and development have gone into producing the superior quality product you have purchased. Your spa is made from the highest quality material and latest technology available today. Pride and meticulous attention to detail have resulted in the spa you have chosen. With proper care, your spa will provide many years of comfort and pleasure.

Please take a few minutes now to read all the instructions before you install your spa. This owner's manual will help you understand your spa, so you will get the most from your investment. For service and advice, do not hesitate to call your authorized dealer. Your questions will be welcomed by friendly and knowledgeable staff.

May you have as much pleasure and enjoyment using your new spa, as we had making it for you.

*We understand there are many choices in the marketplace when you are considering adding a spa to your home, so thank you for choosing a spa by Leisure Manufacturing Inc. **Enjoy!***

SAFETY SIGN

IMPORTANT NOTICE: SAFETY SIGN

Enclosed with this Owner's Manual is a Safety Sign. This sign must be permanently installed in a location that is visible to all spa users. It is the spa owner's responsibility to remind all users about safe spa use, particularly occasional users of the spa, who may not be aware of the various health and safety issues.

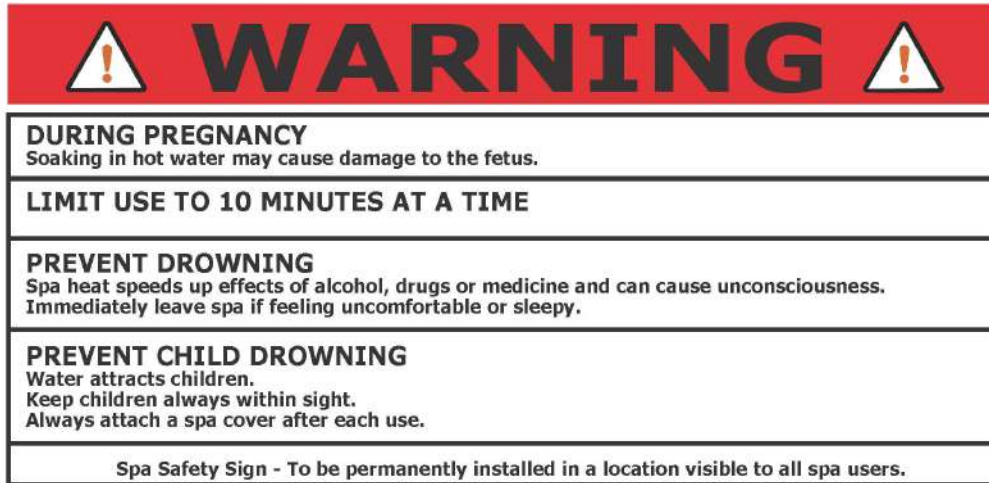

To obtain additional or replacement copies of the safety sign, contact your dealer.

ATTENTION: SPA OWNER

In the immediate vicinity of the spa, a sign must be posted stating the following:

- 1) The spa's address
- 2) Location of the nearest telephone with posted emergency numbers
- 3) Nearest available police department, fire department and ambulance/rescue unit

CONDITIONS OF WARRANTY AND CONSUMER OBLIGATIONS

As a new spa owner, you have specific obligations in regard to the installation and safe use of this spa. Failure to do so may result in a loss of warranty coverage not to mention personal injury to those using this spa.

Inspect the spa upon its arrival for damage. If you are being made aware of this for the first time, your spa may not have been delivered in its original factory packaging. If this is the case, please take time to inspect your spa and report any damage or missing items to your dealer.

- 1) Install the spa both physically and electrically, in accordance with any local codes.
- 2) Provide suitable access to all sides of the spa. Any custom-built enclosure, either above or below a deck surface, must be able to be removed with relative ease.
- 3) Provide sufficient work area around the spa's perimeter especially the side the spa's equipment is located on.
- 4) Regularly check operation of the spa in regard to filtration, jet pump operation and the heating system.
- 5) Report any concern to the dealer. Any problem that arises towards the end of particular warranty coverage should be documented and reported to the dealer
- 6) Maintain the water's chemical balance and clean/replace the system's cartridge filter(s) as instructed by the dealer and/or Leisure Manufacturing Inc.
- 7) Drain and refill the spa on a regular basis as instructed by the dealer and/or Leisure Manufacturing Inc.
- 8) Winterize and store the spa and its' components in accordance with the manufacturer's printed instructions.
- 9) Care for and maintain the spa cabinet, hard cover and acrylic surface as outlined in these instructions.
- 10) Ask your dealer to record the spa's serial number on your bill of sale.
- 11) Provide a copy of your bill of sale, if requested by the dealer or Leisure Manufacturing Inc.

YOUR PERSONAL SPA DATA

Before you begin the installation of your new spa, please take a few minutes to fill out the details of your spa. This information will become invaluable later should you have a question for your dealer or should you need to make a warranty claim. Ask your dealer to assist you in recording this information.

Model Year

Model Name/Number

Spa Serial#

Jet Pump(s) Size (HP, SPL, Watts etc.)

Heater size (kw)

Filter Cartridge (Model Number/Size)

Topside Control/Keypad

Spa Pack Model #

Spa Pack Serial #

Dealer Name

Date of Purchase

We strongly recommend that you attach your bill of sale to this manual after installation is complete. Keep it in a safe place for future reference. You may also wish to attach any notes you have made about the dealer delivery; dealer start up demo or any other notes that may be of benefit in the future.

IMPORTANT SAFETY INSTRUCTIONS

WARNINGS

DANGER: Risk of Accidental Drowning. Extreme caution must be exercised to prevent unauthorized access by children. To avoid accidents, ensure that children cannot use this spa unless they are always supervised.

DANGER: Risk of Injury. The suction fittings in this spa are sized to match the specific water flow created by the pump. Should the need arise to replace the suction fittings or the pump, be sure that the flow rates are compatible.

Never operate spa if the suction fittings are broken or missing. Never replace a suction fitting with one rated less than the flow rate marked on the original suction fitting.

DANGER: Risk of Electric Shock. Install at least 5 feet (1.5m) from all metal surfaces. As an alternative, a spa may be installed within 5 feet of metal surfaces if each metal surface is permanently connected by a minimum 8 AWG (8.4mm²) solid copper conductor to the wire connector on the terminal box that is provided for this purpose.

DANGER: Risk of Electric Shock. Do not permit any electrical appliance, such as a light, telephone, radio, or television, within 5 feet (1.5m) of a spa.

WARNING: To reduce the risk of injury:

- a) The water in a spa should never exceed 40 °C (104 °F). Water temperatures between 38 °C (100 °F) and 40 °C are considered safe for a healthy adult. Lower water temperatures are recommended for young children and when spa use exceeds 10 minutes.
- b) Since excessive water temperatures have a high potential for causing fetal damage during the early months of pregnancy, pregnant or possibly pregnant women should limit spa water temperatures to 38 °C (100 °F).
- c) Before entering a spa, the user should measure the water temperature since the tolerance of water temperature-regulating devices varies.
- d) The use of alcohol, drugs, or medication before or during spa use may lead to unconsciousness with the possibility of drowning.
- e) Obese persons and persons with a history of heart disease, low or high blood pressure, circulatory system problems or diabetes should consult a physician before using a spa.
- f) Persons using medication should consult a physician before using a spa since some medication may induce drowsiness while other medication may affect heart rate, blood pressure, and circulation.



CAUTION:

Maintain water chemistry in accordance with the manufacturer's instructions.

READ AND FOLLOW ALL INSTRUCTIONS

When using this equipment, basic safety precautions should always be followed. Including the following:

- a) A green coloured terminal or a terminal marked G, GR, Ground, Grounding or the international grounding symbol is located inside the supply terminal box or compartment. To reduce the risk of electric shock, this terminal must be connected to the grounding means provided in the electric supply service panel with a continuous copper wire equivalent in size to the circuit conductors supplying this equipment.
- b) At least two lugs marked "BONDING LUGS" are provided on the external surface or on the inside of the supply terminal box or compartment. To reduce the risk of electric shock, connect the local common bonding grid in area of the hot tub or spa to these terminals with an insulated or bare copper conductor not smaller than No.6 AWG.
- c) All field-installed metal components such as rails, ladders, drains or other similar hardware within 3m (10ft) of the spa or hot tub shall be bonded to the equipment grounding bus with copper conductors not smaller than No.6 AWG.

DO NOT connect your spa to an extension cord.

SAVE THESE INSTRUCTIONS

IMPORTANT SAFETY INSTRUCTIONS

Hyperthermia

Prolonged immersion in hot water may induce hyperthermia. Hyperthermia occurs when the internal temperature of the body reaches a level several degrees above the normal body temperature of 37 °C (98 °F). The symptoms of hyperthermia include drowsiness, lethargy, and an increase in the internal temperature of the body. The effects of hyperthermia include:

- Unawareness of impending hazard
- Failure to perceive heat
- Failure to recognize the need to exit spa
- Physical inability to exit spa
- Fetal damage in pregnant women
- Unconsciousness and danger of drowning



WARNING:

The use of alcohol, drugs or medication can significantly increase the risk of fetal hyperthermia.

INSTALLATION INSTRUCTIONS

Remember, your new spa is a powerful piece of electrical and plumbing equipment. You owe it to yourself, your family and your friends to install it correctly and safely. Before attempting to hook-up or use your spa, please read the following instructions.



ATTENTION:

This spa is intended for outdoor use; however it can be installed indoors when precautions are taken to ensure the spa is installed and located in such a manner that any water that could leak, splash or be released as humidity will drain away harmlessly.

POSITIONING OF YOUR SPA - CONSIDERATIONS

Your spa is completely self-contained. Therefore, you can situate it just about anywhere; on a patio, in or on a deck, in a basement or sunroom. It comes completely pre-plumbed and water tested from the factory. Never lift or carry the spa by the plumbing. Damage could occur which would not be covered under warranty.

You should consider the following when selecting prospective spa sites in order to maximize enjoyment.

To avoid any personal injury or damage to your spa, have 4-5 people ready to assist you to move the spa to its' final location. Use a moving dolly and/or straps to distribute the spa's weight more evenly. Never lift or carry the spa by its' plumbing.

SITE CONSIDERATIONS

Local codes	Local building, property and electrical codes may affect your installation.
Delivery access to location	Gates, overhangs, fences, gas meters, and AC units may become obstructions. You may need to access from a neighbour's yard or employ a crane.
Vegetation in spa area	Trees, bushes, flowers etc. can all add to spa maintenance.
Spa location relative to buildings	The location could add to your spa maintenance (removing snow from cover) and increase operating costs.
Fences, tree lines	More privacy during use and serves as a wind break but may also add more maintenance.
Spa step out location	Any surface that is slippery when wet could be dangerous for bathers both entering and exiting the spa.
Spa Direction	View when using a lounger & ease of access for servicing.
Downspouts and natural drainage of land	These may flood the spa area, damage spa or create a safety hazard to bathers.
Outside water supply and draining location	You will need a place to safely drain the spa and a way to refill it easily.
Optional accessories	These may take up added space that you must plan for (cover remover/holder).

SPA SUPPORT

Whatever the support is, it must be:

- a) A continuous, level surface, above grade, capable of handling 80 lbs. per sq. ft. that will not be compromised by changes in the water table or water sitting in the area.
- b) Such that the weight of the spa, water and bathers is not supported by the spa lip.
- c) In full contact with the bottom of the spa

ACCEPTABLE SPA SUPPORT BASES

Concrete Pad	4" to 6" thick with provision for run off
Patio Stones, Pavers etc.	Levelled with proper preparation of the earth
Wooden Deck Floor	Incl. centre support uprights in concrete and joists spaced 12" on centre
Engineered Plastic Spa Pad	Following pad manufacturer's instructions

Unacceptable Spa support bases include crushed gravel, stone dust, bare earth, platform built directly onto earth. **Damage caused by improper spa installation will void factory warranty.**

Do NOT locate your spa in a low run-off area since melting snow or rain can cause pump and equipment damage. WATER SHOULD ALWAYS DRAIN AWAY FROM THE SPA.

See next page for dimensions that can be used to determine the proper location of submerged conduits in concrete slab installations. All dimensions are made from the outside of the spa's frame with the access panels removed.



ELECTRICAL CONNECTION GENERAL INFORMATION

A. LOCATING A CONDUIT WITHIN A CONCRETE PAD

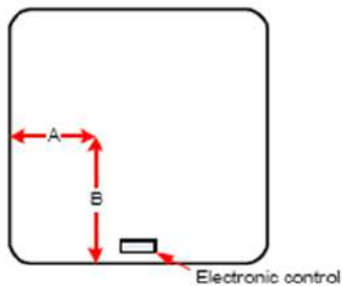

If your intent is to bring a conduit and power wires up under the spa, we suggest that it enter the spa cavity in the front, left corner; 6" (15cm) Dimension A in from the left and 6" (15cm) Dimension B up from the front. See A & B on the diagram below. This location will allow you to stay clear of spa pumps and other equipment while giving you a short and easy access to the left side of the spa pack, where the electrical entry hole and terminal block are located.

B. SUPPLY CABLE ENTRY INTO SPA EQUIPMENT AREA

- You may enter the spa cavity at any other point around spa provided you have reviewed the location and determined there is no interference. You may also decide to enter at an adjoining wall (depending on the positioning of the spa) and route a conduit along the spa kicker. Ask your electrician for his/her advice in these matters.
- In all cases the best side for entry of the supply cable is the side to your left when you are standing at the equipment panel.
- Right side entry is possible; however, this may involve additional supply cable, parts, and time.

HOW TO PASS THE CABLE THROUGH THE SPA ENCLOSURE

Polysteel Frame with Polyethylene Bottom and Polysteel Panels

- a) You can choose to notch the Polysteel panel so you can pass the cable/conduit through and still be able to remove/replace the panel for servicing. You should consider securing the cable or conduit to the spa's metal frame where cable/conduit passes through the cabinet.
- b) You may also route a cable up under the corner. The curved panel is flexible enough and there is enough space to run the cable this way. Removing the corner may help you to do this easier.
- c) On a concrete pad where you have a conduit or cable coming up within the perimeter of the spa, you can easily cut an opening in the polyethylene bottom to access the cable or conduit/wires. See above table for recommended opening location.

You may wish to insulate any opening or cut-out you make in the spa's cabinet panel or corner or bottom to keep cold air and small animals out.

NORTH AMERICAN (60HZ) MODELS

Please note the following important information:

When using this electrical equipment, basic safety instructions should be followed, including the following:

Read and Follow ALL Directions

- 1) Electrical installation must be carried out by a qualified electrician strictly in accordance with local governing codes.
- 2) A terminal marked "ground" is located within the control box. To reduce the risk of electric shock this terminal must be connected to the grounding means provided in the electric supply service panel with a continuous copper wire equivalent in size to the circuit conductors supplying the equipment.

- 3) At least two lugs marked "bonding lugs" are provided on the external surface of the control box. To reduce the risk of electric shock, connect the local common bonding grid in the area of the hot tub or spa to these terminals with an insulated or bare copper conductor not smaller than No. 6 AWG.
- 4) All field installed metal components such as rails, ladders, drains or other similar hardware within 3m (10 ft.) of the spa or hot tub shall be bonded to the equipment grounding bus with copper conductors not smaller than No. 6 AWG.
- 5) Test the ground fault circuit interrupter before each use of the spa.
- 6) Before servicing any electrical components of the system make sure that the power supply is switched off.

ATTENTION: ELECTRICIAN & SPA OWNER

PICO FUSE



Balboa Spa packs contain a special fuse, referred to a “Pico fuse”.

This special fuse is designed to open (burn out) if:

- a) There is any problem with how the electrical supply is connected
- b) There is a power surge to the spa pack

This fuse is not replaceable and the entire spa pack is considered destroyed.

WARNING!



**THIS IS NOT A CONDITION THAT IS COVERED UNDER THE
SPA PACK MANUFACTURER’S WARRANTY OR
LEISURE MANUFACTURING’S COMPREHENSIVE SPA WARRANTY.**

230V SUPPLY CONNECTION

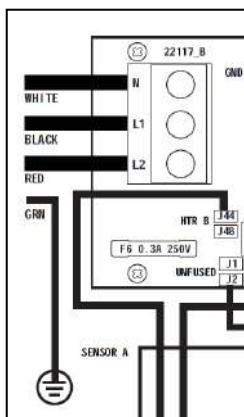

BP SERIES SPA PACK

Power Requirements

240VAC, 60Hz, Class A GFCI-protected service

4 wires (Hot-Line 1, Hot-Line 2, Neutral, Ground)

For current requirements & breaker rating see nameplate on spa.

Power Up Screen

Each time the system powers up, a series of numbers is displayed. After the start-up sequence of numbers, the system will enter Priming Mode. Next, refer to the User Guide for your keypad at the back of this manual.

CAUTION:



Electrical installation must be carried out by a qualified electrician strictly in accordance with local governing codes.
Use only Class A Ground Fault Circuit Interrupter.

TYPICAL NORTH AMERICAN GFCI

Several different models of GFCIs are available on the market. Note that our illustrations are generic.

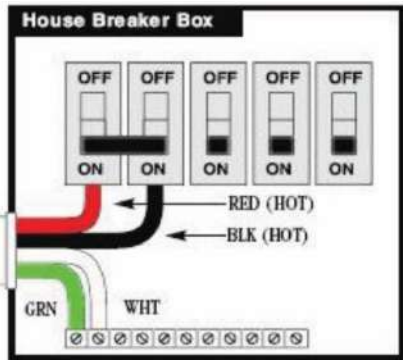
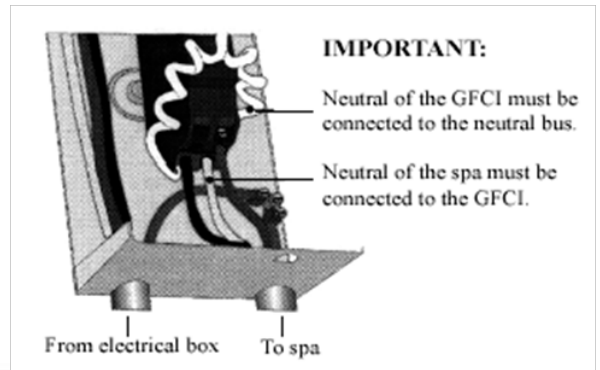

Important: Installation of this GFCI Circuit Breaker, including Ampere sizing and selection of conductor size and type, must be performed by a qualified electrician in accordance with the National Electrical Code, or the Canadian Electrical Code, and all federal, state, and local codes and regulations in effect at the time of installation.

Note: The white Neutral wire from the back of the GFCI must be connected to the incoming Line Neutral. The internal mechanism of the GFCI requires this neutral connection. The GFCI will not work without it.

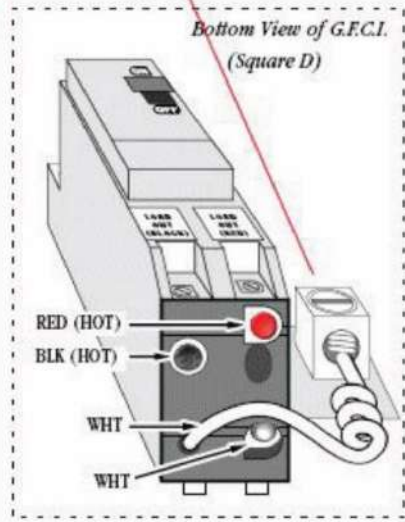
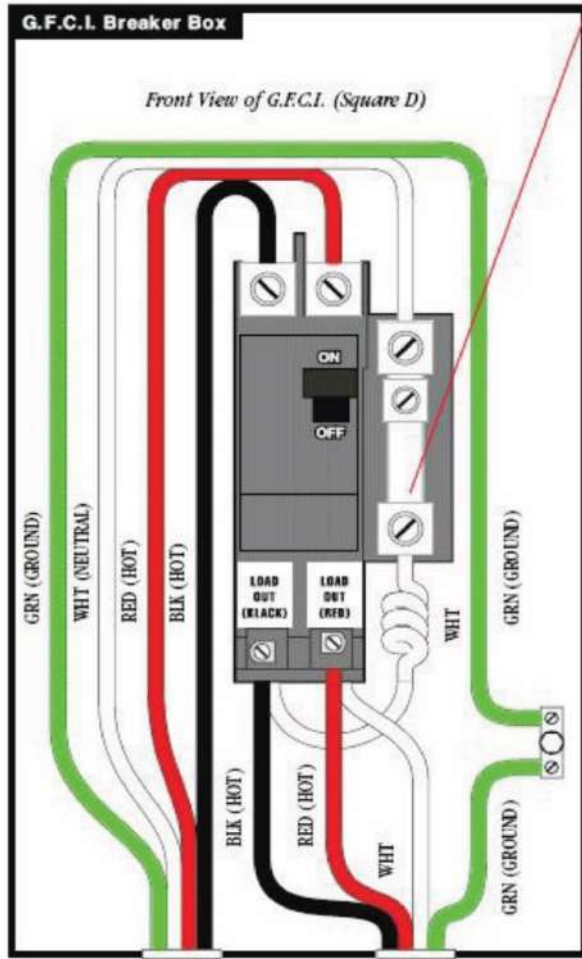

To connect spa pack, refer to electrical diagram located on next page

Wire Size and Over Current Protection (Canada/US)

Amp rating of spa		Supply Wire type and size		Over Current Protection (amps)
More than	To	60C copper, AWG	75C copper, AWG	
16	20	10	10	25
20	24	10	10	30
24	28	8	10	35
28	32	8	8	40
32	36	6	8	45
36	40	6	8	50
40	48	4	6	60

Note: If your GFCI trips immediately on start-up or during the opening use of the spa, DO NOT USE THE SPA and take precautions to ensure that no one uses the spa, while you contact your dealer/electrician. GFCI trips on newly installed spas are predominantly caused by mis-wired GFCIs.

SPECIAL NOTE: DISCONNECT SWITCH

This unit must be connected to a disconnect that de-energizes power to the entire unit for servicing, maintenance or the like. The disconnect switch, with marked "OFF" position, must be located within sight from the equipment and at least 5ft. (1.52m) from the inside walls of the spa.

SPECIAL NOTE: EMERGENCY SWITCH

This unit is intended for use in a single-family dwelling. When used in locations other than a single-family dwelling, a clearly labelled emergency switch, readily accessible to the occupants and at least 5ft. (1.52m) away from the unit, shall be provided as part of the installation.

EUROPEAN (50HZ) MODELS

Please note the following important information:

When using this electrical equipment, basic safety instructions should be followed, including the following:

Read and Follow ALL Directions

- (1) This spa must be connected to an RCD (Residual Current Detector) with a residual operating current not exceeding 30mAmps.
- (2) Electrical installation must be carried out by a qualified electrician strictly in accordance with local governing codes.
- (3) A terminal marked "ground" is located within the control box. To reduce the risk of electric shock this terminal must be connected to the grounding means provided in the electric supply service panel with a continuous copper wire equivalent in size to the circuit conductors supplying the equipment.
- (4) At least two lugs marked "bonding lugs" are provided on the external surface of the control box. To reduce the risk of electric shock connect the local common bonding grid in the area of the hot tub or spa to these terminals with an insulated or bare copper conductor not smaller than No. 6 AWG.
- (5) Test the RCD before each use of the spa, according to the manufacturer's instructions.
- (6) Before servicing any electrical components of the system make sure that the power supply is switched off.
- (7) Keep the door closed in order to provide IPX5 protection to the electrical compartment.

Any opening made through the spa enclosure for the entry of input cables/wires, must be made watertight to preserve the IPX5 rating of the appliance.

ATTENTION: ELECTRICIAN & SPA OWNER

PICO FUSE



Balboa Spa packs contain a special fuse, referred to a “Pico fuse”.

This special fuse is designed to open (burn out) if:

- c) There is any problem with how the electrical supply is connected
- d) There is a power surge to the spa pack

This fuse is not replaceable, and the entire spa pack is considered destroyed.

WARNING!



THIS IS NOT A CONDITION THAT IS COVERED UNDER THE
SPA PACK MANUFACTURER’S WARRANTY OR
LEISURE MANUFACTURING’S COMPREHENSIVE SPA WARRANTY.

TYPICAL RESIDUAL CURRENT DETECTOR (RCD)



A residual current device (RCD,) is the generic term for a device that monitors the current in the line conductor and the neutral conductor of a circuit in an earthed system.

In a circuit that’s operating properly, the vector sum of the live and neutral current values added together will be zero. Current flowing to earth, due to a line earth fault, will return via the earth conductor, and regardless of load conditions, will be registered as a fault. This current flow will give rise to a residual current that will be detected by the device. If the residual current exceeds the rated sensitivity of the RCD, it will automatically activate a tripping of the faulty circuit.

<- Two Pole RCD

Typical specifications are as follows:

- Residual Current Devices (RCD’s) range
- Sensitivity - from 10 to 500mA
- Voltage - 2 poles : 230V; 3/4 poles: 230/400V
- Connection capacity
- 25A: 6/10 mm² (flexible/ rigid cable)
- 40,60A: 16/25 mm²
- 80,100A: 35/50 mm²



<- Four Pole RCD

230 VOLT SUPPLY CONNECTION

A) SRBP200G1 SPA PACK

Power Requirements:

Single Service [3 wires (line, neutral, ground)]
230VAC, 50/60Hz, 1p, 16A (Circuit Breaker rating =20A max.)

Single Service [3 wires (line, neutral, ground)]
230VAC, 50/60Hz, 1p, 32A (Circuit Breaker rating =40A max.)

IMPORTANT: If you want to run this spa pack on a 1 x 32 Amp single service you must:

- Move dipswitch #2 on switchbank S1 to the ON position
- Move dipswitch #5 on switchbank S1 to the OFF position

See wiring diagram (back of cover for spa pack) for switchbank location

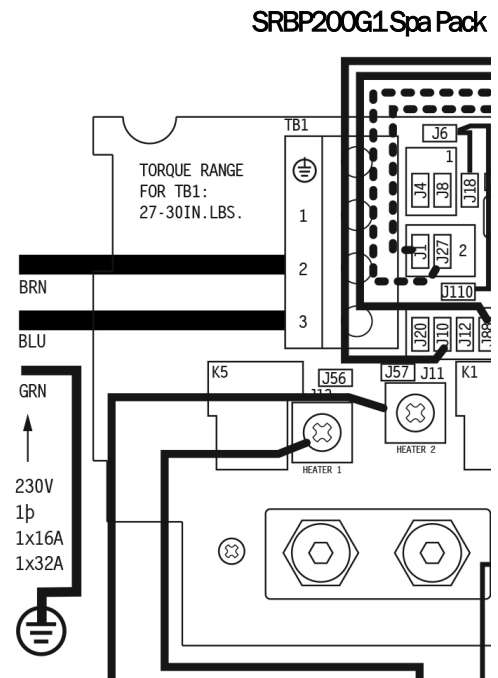

B) SRBP2100X SPA PACK

Power Requirements:

Single Service [3 wires (line, neutral, ground)]
230VAC, 50Hz, 1p, 32A (Circuit Breaker rating =40A max.)

Dual Service N/A

230VAC, 50/60Hz, 1p, 32A (Circuit Breaker rating =40A max.)

3-Service [5 wires (line 1, line 2, line 3, neutral, ground)]

400VAC, 50Hz, 3p, 16A (Circuit Breaker rating =20A max each phase line.)

IMPORTANT – Service must include a neutral wire, with a line to neutral voltage of 230VAC.

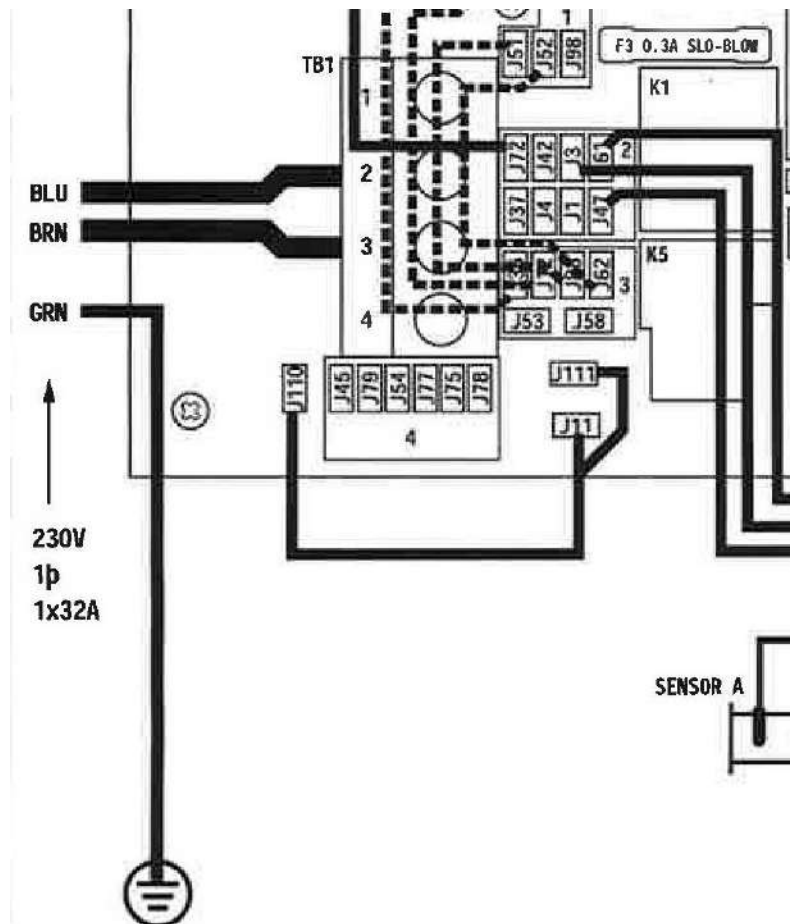

SRBP2100X
Spa Pack – Single Service

CONVERSION FROM SINGLE SERVICE TO 3-SERVICE

1. Remove the jumper wire from J51 (Area 1) to J88 (Area 2)
2. Remove the jumper wire from J52 (Area 1) to J62 (Area 2)
3. Move the jumper wire attached to J60 from J36 in Area 3 to J45 in Area 4. (J60 to J45)
4. Move the jumper wire attached to J41 from J12 in Area 3 to J79 in Area 4. (J41 to J79)
5. Set DIP Switches A2 and A5 to OFF.
6. Terminal block must be wired according to the 3-Phase illustration on the wiring diagram

1. Line 1 - Brown
2. Neutral - Blue
3. Line 2 - Brown
4. Line 3 - Brown

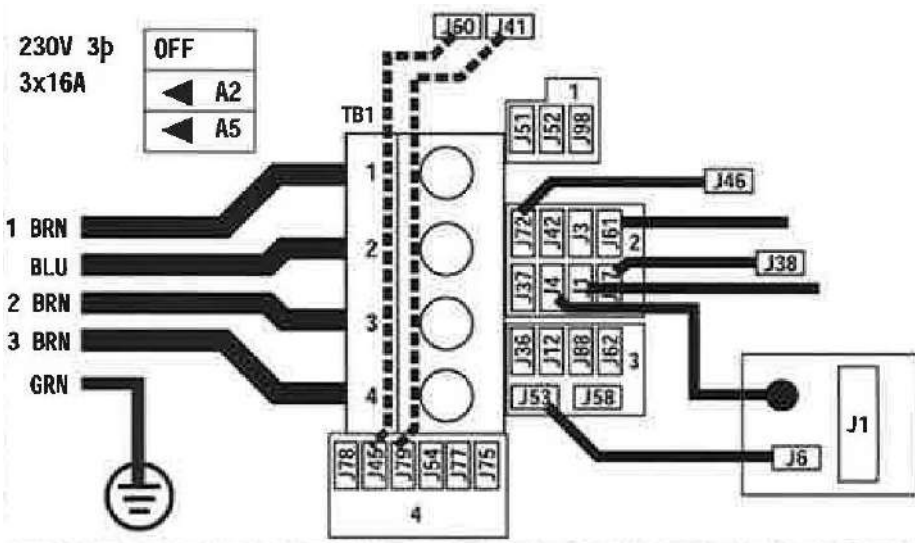

SRBP2100X Spa Pack - 3-Service

Power Up Screen

Each time the system powers up, a series of numbers is displayed. After the start-up sequence of numbers, the system will enter Priming Mode. Next, refer to the User Guide for your keypad at the back of this manual.

Wire Size and Over Current Protection

Total Ampere Rating of Power System	Minimum Wire Size Use Copper ONLY With 90 °C Insulation	Ampere Rating of RCD Circuit-breaker
0A to 16A	#12 AWG	20
16A to 20A	#10 AWG	25
20A to 24A	#10 AWG	30
24A to 28A	#8 AWG	35
28A to 32A	#8 AWG	40



WHAT'S INSIDE YOUR SPA

HYDROTHERAPY JETS

A variety of jet sizes and internal styles are used in unique seating patterns to achieve superior hydrotherapy in individual spa models. Therefore, not every jet described or pictured below is in every model. Not all jet internal styles are available in all jet sizes.

To adjust the water volume, simply turn the jet face clockwise to the off position or counter clockwise to the maximum position. If you move too hard to maximum you will release the internal from the jet body.

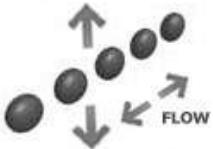
ADJUSTABLE VOLUME JETS STYLE: Omni Majestic			
			
POWER (Directional)	POLY (Multi-Massage)	MINI (Twin-Roto)	CLUSTER (Directional)
5 1/4" 133.35mm	5 1/4" 133.35mm	5 1/4" 133.35mm	5 1/4" 133.35mm

NOZZLE STYLES & THEIR HYDROTHERAPY EFFECT			
			
Directional	Twin-Roto	Multi-Massage	

FIXED VOLUME JETS		
		
MICRO	OZONE	LARGE OZONE
1 ¼" 31.75mm	1 3/8" 41.27mm	2" 50.80mm

OTHER JETS - May not be in your spa model		
		
AIRMAX	WHIRLPOOL	MASTER MASSAGE
2 5/16" 58.74mm	5 ¼" 133.35mm	7 ½" 190.5mm
<ul style="list-style-type: none"> • Solo Stream • Tri-Stream • Multi-Stream Max air in water/air mix for a soft therapy effect	<ul style="list-style-type: none"> • Max volume – adjustable • Wide comfortable stream 	<ul style="list-style-type: none"> • High volume adjustable

OTHER INTERNAL FITTINGS



Suctions

These multi-holed, anti-vortex fittings in the footwell provide the intake water for the pump(s). A powerful suction is produced here when the jet pumps are turned on. On systems with a circulation pump, the bypass suction fitting (smaller than regular suction), may have little to no suction on it, since the circulation pump has a lower flow than the jet pump and the suction is only active as the filter(s) become clogged.

All suctions in our spas are VBG compliant for your safety.



Perimeter LED Lighting

These round or hex shaped, multi-faceted fittings, located on the vertical spa wall and deck of the spa, are the lenses for the LED light outputs. *(Not available on all models)*



Ozone/AquaNova Returns

These special thru wall fittings return water to your spa that has passed through the ozone or AquaNova system. If you do not have either ozone or AquaNova on your spa, these fittings will not be present.



Skimmer

Floating guillotine-style weir that provides skimming action to remove surface debris with an easily accessible basket from which debris can be dumped.



Aromatherapy Canister

Found under the filtration plate, the aromatherapy canister is easy to use by simply opening the valve and dispensing the desired amount of aromatherapy beads into the canister.



Clean Sweep Fitting

The unique Clean Sweep Fitting, located in the footwell of the spa is designed to push dirt and debris on the spa floor towards the suction(s) on the filtration pump (pump 1) so that it can quickly be trapped in the spa's filter.

DECK CONTROLS



Eclipse

Air Controls

Located on the deck of the spa, these valves control the amount of air being mixed with the water stream at each jet. The minimum to maximum movement is approximately $\frac{1}{4}$ turn or on/off for toggle type. More air will increase the massage effect from the jet. Proper air draw is achieved when the jet pump is operating on high speed, particularly if the pump is a 2-speed pump.



Eclipse

On/off Water Valve

This positive seal valve is used to turn the water feature on/off. Adjust it as needed to achieve the best effect from the water feature.

WATER FEATURES



LED Water Laminars

The special waterspouts create a water rope effect arching up and then into the spa. When the Light key on the keypad is pressed, these ropes transmit the LED colours as part of a dazzling light show.

MISCELLANEOUS



LED Spa Light

This clear or slightly bluish fitting is usually in the vertical surface of the spa steps. It is controlled by a designated switch on the keypad. It serves as a safety feature; lighting the spa's contours for those entering or exiting the spa.



Head Cushions

The head cushions you will find in our spas are designed to add comfort to your spa experience. Rest your head as you sit back and enjoy the hydrotherapy. You'll find all our head cushions functional and comfortable.

WHAT'S UNDER YOUR SPA (THE EQUIPMENT)



The spa's control pack, heater, drain connection and ozonator may be accessed by removing the cabinet panel along the control side of the spa. Removing the panel(s) to the right or left of the spa's main access panel will allow access to the jet pumps, blower and any other optional equipment. On some models, all equipment is accessible from the main access panel.

The **free standing spa pack** houses the receptacles and switching apparatus (circuit board) for the pump(s) blower, light, keypad etc., as well as the heat regulating system. The spa pack is also where the electrical supply connections are made. The **horizontal heater** is attached to the bottom of the spa pack.



2-Speed Jet Pump

A high performance 2-speed jet pump provides the power to operate the various hydrotherapy jets in the spa, at the optimum level. The low speed of pump 1 is used to circulate the water so it can be filtered and heated. Some models may have a 2nd jet pump to properly power the jets. Gate valves in the plumbing lines allow easy servicing of the pump and heater. Safety clips on the valve shafts keep the valves open during use.



Ozonator

An ozonator is used to assist in water treatment. The corona discharge (CD) model produces ozone which is drawn into the spa water via the return plumbing.



O3/UV (AquaNova)

This unit creates both ozone and UV in perfect synergy to treat the spa water. Ozone introduced into the unit's chamber reacts with the UV light to create hydrogen free radicals for advanced oxidization potential (AOP). This results in only oxygen bubbles emerging from the dual return fittings.

Other items under your spa may include an audio power supply, audio receiver and LED control system.

START-UP

HOW YOUR SPA WORKS

Circulating, Heating and Filtering

Low speed of a 2-speed pump (depending on model).

Immersion heating element within a stainless-steel heater barrel.

Filter System

Single or two-cartridge system that is accessible from inside the spa.

Hydrotherapy

2-speed jet pumps provide a gentle, low-speed therapy or intense, high-speed therapy. The jets have directional nozzles, multiple directional nozzles, fixed nozzles, or rotating nozzles. Most of the jets can have the water volume adjusted to your therapy needs.

Deck Controls

Air controls mix air with the water stream coming out of the jet. A diverter valve is used on some models to dedicate pump flow to specific groups of jets or share it amongst several jets. Models with the waterfall feature have a control valve to turn the waterfall on/off.

A digital topside control panel allows you to activate the pumps, blower and light plus set the temperature that you want the water to be. The topside display also shows error messages and tells you if any special spa pack features are operating, including protection against overheating and freeze-up.

Lighting

Your spa is equipped with a multi-LED spa light allowing you to enjoy the effects of a colour changing LED light system. LED lights around the perimeter of the spa create a special effect of colour changing lights.

LED Light Operation

Your spa may be equipped with an LED light system consisting of perimeter lights, lighted water feature(s), lighted corners and a thru wall underwater spa light, depending on the spa model and options. The system is controlled using the LIGHT key on the topside control panel. The spa pack is factory set/programmed for simple on/off spa light operation. Note that not all colours are available on all LED systems.

Operation: To move from setting to setting simply turn the LIGHT key on/off.

If the light is turned OFF for more than 5 seconds, the sequence automatically restarts at the last colour shown.

Light Sequence (Ultrabrite - with integrated output for additional LEDs)

Slow Cycle

White (Blue, Green and Red mix)

Aqua (Blue and Green mix)

Magenta (Blue and Red mix)

Blue

Gold (Red and Green mix)

Green

Red

Flash

Strobe

Light Sequence (Control 40/50)

White (Red, Green, Blue mix)

Aqua (Green and Blue mix)

Magenta (Blue and Red mix)

Blue

Gold (Red and Green mix)

Green

Red

Colour Flash (Quick rotation of all colours)

Slow Colour Wheel (Slow rotation of all colours)

Colour Wheel (Gradual rotation of all colours)

FILLING YOUR SPA

Okay, your new spa has been connected to the power and you have a basic understanding of how the equipment works and what the jets can do for you. We know you are anxious to fill the spa and get it started, but please read this section carefully before you fill your spa.

- 1) Make certain that the breaker or fuse(s) that supplies your spa equipment is off.
- 2) Wash the spa surface thoroughly with warm water and a soft cloth only to remove any construction or transportation debris.
- 3) Check that the drain connection is closed.
- 4) Check that the unions on the spa pack and pump(s) are tight. They can loosen during transportation.
- 5) Open waterfall/water feature ON/OFF valve before filling. Refer to graphics on valve handle or simply turn counter clockwise to open.
- 6) Begin filling the spa with a standard garden hose. Fill by inserting hose into skimmer body. Do not fill your spa with soft water (consult dealer). If possible, your source fill water temperature should not be less than 70°F (21°C). Do Not operate the spa with low water levels. A level 4" over the bottom of the skimmer mouth is recommended. Maximum initial water level should be 6" below the spa lip. Adjust as needed based on number of bathers using the spa. Consider adding an overflow to your spa if you are regularly having enough bathers in the spa to significantly raise the water level such that damage to equipment may occur.
- 7) Increase the fill pressure slowly to prevent surface damage by a jerking hose.
- 8) Visually check all lines for leaks and correct immediately. If you cannot stop the leak simply by tightening a union or resetting an "O" ring or gasket, contact your dealer immediately.
- 9) Turn on the main power at your electrical panel.
- 10) The topside control panel will initialize and begin its' start-up procedure. Then the system will start the circulation pump (or low speed pump) and the heater.
- 11) Bleed entrapped air off the filter by opening the air bleed screw on the filter lid.

IMPORTANT:

**Now, read about the keypad operation, user settings, system defaults, automatic functions and display messages included in this manual (see User Guide in the Index).
Take a few minutes to try the various keys and features on your new spa.**

Once you feel comfortable with the operation of your spa's controls, set the temperature to the desired level (100°F/38°C is an excellent starting point). Close the air controls and cover the spa with your hard cover. Heat up times will vary based on volume of water in the spa, but you can generally expect 6-8 hours to reach maximum temperature. Spas running on 120VAC will have a longer initial heat-up time.

Always view the temperature display before entering the water. For your own personal safety, do not enter when the temperature exceeds the maximum set point of 40°C (104°F).

M8 TECHNOLOGY

All Balboa BP series spas packs have a Smart Technology called M8 built in. Depending on the spa pack version/software the M8 feature may be disabled.

M8 works when the system is in ready mode. Polling (a periodic check of the water temperature) happens every 30, 60, 90 or 120 minutes. These intervals are known as the M8 Cycle timer. 120-minute cycle times can save energy and may prolong the life of the pump. Stable water temperature will result in a 120-minute cycle time. If the water temperature drops significantly enough the M8 cycle timer may eventually drop to 30 minutes.

Besides prolonging pump life, the M8 system may also reduce the noise level that some experience whenever the pump turns on. M8 will save a modest amount of energy, compared to when it is disabled.

Dashes (---) will appear on your keypad display in place of the temperature readout whenever the temperature has not been measured in more than 60 minutes. Hence, the system is in M8 “mode”. The dashes will also appear on system start-up until the water temperature has been measured at which time the actual temperature will replace the dashes.

Touchscreen controls can show you the M8 cycle time as well as to enable/disable the system. Traditional controls with an LCD display and tactile buttons do not have the ability to turn M8 on/off depending on the software setup.

For more information on M8 please visit:

www.balboawatergroup.com/m8 OR <https://bestlifehotubs.com/>

TP500S CONTROL PANEL USER GUIDE

TP500 and TP500S Control Panels

User Guide for Standard Menu

System Model: All BP series systems

Panel Model: TP500 and TP500S Series

Panel Software Version: All versions



TP500S



TP500

Display Icons



- | | | |
|-----------------------------|-------------------|---|
| A - Heat | F - Light | K - Auxiliary (Jets 3 or MICROSILK) |
| B - Ready Mode | G - Cleanup Cycle | L - Temperature Range (High / Low) |
| C - Rest Mode | H - Jets 1 | M - Set (Programming) |
| D - bba™2 On | I - Jets 2 | N - Filter Cycle (1 or 2 or Both) |
| E - WiFi (Cloud Connection) | J - Blower | O - AM or PM (Time) |

MicroSilk® is a registered trademark of Jason International.

Manufactured under one or more of these patents. U.S. Patents: 5332944, 5361215, 5550753, 5559720, 5,863,459, 6253227, 6282370, 6590180, 6970062, 6986815, 7030343, 7,417,834, 62. Canadian Patent: 2342614, Australian patent: 2373248 other patents both foreign and domestic applied for and pending. All material copyright of Balboa Water Group.



Main Menu

Navigation

Navigating the entire menu structure is done with 2 or 3 buttons on the control panel.

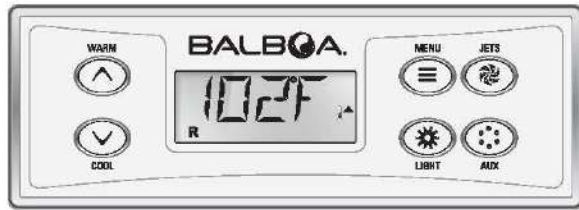

Some panels have separate WARM (Up) and COOL (Down) buttons, while others have a single Temperature button. In the navigation diagrams Temperature buttons are indicated by a single button icon. Panels that have two Temperature buttons (Warm and Cool) can use both of them to simplify navigation and programming where a single Temperature icon is shown.

The MENU/SELECT Button is used to choose the various menus and navigate each section.

Typical use of the Temperature button(s) allows changing the Set Temperature while the numbers are flashing in the LCD. The menu can be exited with certain button presses. Simply waiting for a few seconds will return the panel operation to normal.

Power-up Screens

Each time the System powers up, a series of numbers is displayed. After the startup sequence of numbers, the system will enter Priming Mode (See Page 3).

Key

- █ Indicates Flashing or Changing Segment
- █ Indicates Alternating or Progressive Message - every 1/2 second
- A temperature button, used for "Action"
- Menu/Select button
- Waiting time that keeps the last change to a menu item.
- ***** Waiting time (depends on menu item) that reverts to original setting and ignores any change to that menu item.

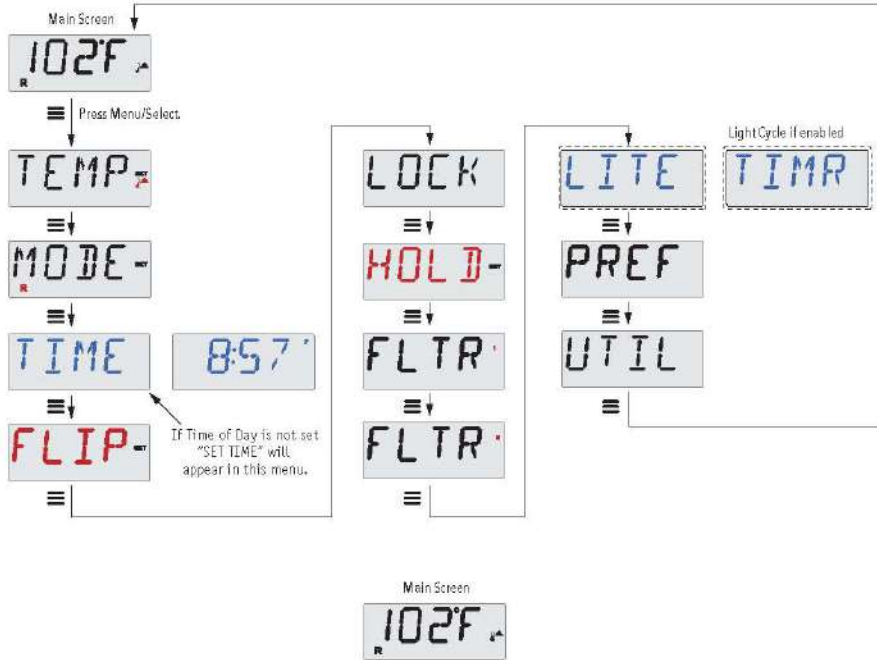

Indicates a Menu Item that Depends on a Menu Factory Configuration and may or may not appear.

Waiting a few seconds in the Main Menu will allow the display to revert to the Main Screen. Most changes are not saved unless Menu/Select is pressed. Refer to key above.

Manufactured under one or more of these patents: U.S. Patents: 5332944, 5361215, 5550763, 5558720, 5,883,469, 6253227, 6282370, 6590188, 6976052, 6966815, 7030343, 7,417,834 12, Canadian Patent: 2342614, Australian patent: 2373248 other patents both foreign and domestic applied for and pending. All material copyright of Balboa Water Group.



Fill it up!

Preparation and Filling

Fill the spa to its correct operating level. Be sure to open all valves and jets in the plumbing system before filling to allow as much air as possible to escape from the plumbing and the control system during the filling process.

After turning the power on at the main power panel, the top-side panel display will go through specific sequences. These sequences are normal and display a variety of information regarding the configuration of the hot tub control.

Priming Mode - MO19*

This mode will last for 4-5 minutes or you can manually exit the priming mode after the pump(s) have primed.



Regardless of whether the priming mode ends automatically or you manually exit the priming mode, the system will automatically start normal heating and filtering at the end of the priming mode. During the priming mode, the heater is disabled to allow the priming process to be completed without the possibility of energizing the heater under low-flow or no-flow conditions. Nothing comes on automatically, but the pump(s) can be energized by pushing the "Jets" or "Aux" buttons.

If the spa has a Circ Pump, it can be activated by pressing the "Light" button during Priming Mode.

Priming the Pumps

As soon as the above display appears on the panel, push the "Jets" button once to start Pump 1 in low-speed and then again to switch to high-speed. Also, push the "Jets 2" or "Aux" button, if you have a 2nd pump, to turn it on. The pumps will now be running in high-speed to facilitate priming. If the pumps have not primed after 2 minutes, and water is not flowing from the jets in the spa, do not allow the pumps to continue to run. Turn off the pumps and repeat the process. Note: Turning the power off and back on again will initiate a new pump priming session. Sometimes momentarily turning the pump off and on will help it to prime. Do not do this more than 5 times. If the pump(s) will not prime, shut off the power to the spa and call for service.

Important: A pump should not be allowed to run without priming for more than 2 minutes. Under NO circumstances should a pump be allowed to run without priming beyond the end of the 4-5 minute priming mode. Doing so may cause damage to the pump and cause the system to energize the heater and go into an overheat condition.

Exiting Priming Mode

You can manually exit Priming Mode by pressing the "Warm" or "Cool" button. Note that if you do not manually exit the priming mode as described above, the priming mode will be automatically terminated after 4-5 minutes. Be sure that the pump(s) have been primed by this time.

Once the system has exited Priming Mode, the top-side panel will momentarily display the set temperature but the display will not show the water temperature yet, as shown below.

This is because the system requires approximately 1 minute of water flowing through the heater to determine the water temperature and display it.



*MO19 is a Message Code. See Page 18.

Manufactured under one or more of these patents. U.S. Patents: 5332944, 5361245, 5550753, 5559720, 5,983,450, 6253227, 6292370, 6590188, 6976052, 6965945, 7030343, 7,417,834 b2, Canadian Patent: 2340614, Australian patent: 2373248 other patents both foreign and domestic applied for and pending. All material copyright of Balboa Water Group.

BALBOA
water group

Spa Behavior

Pumps

Press the "Jets" button once to turn pump 1 on or off, and to shift between low and high speeds if equipped. If left running, the pump will turn off after a time-out period.

On non-circ systems, the low-speed of pump 1 runs when the blower or any other pump is on. If the spa is in Ready Mode (See page 6), Pump 1 low may also activate once in a while for at least 1 minute to detect the spa temperature (polling) and then to heat to the set temperature if needed. When the low-speed turns on automatically, it cannot be deactivated from the panel, however the high speed may be started.

Circulation Pump Modes

If the system is equipped with a circ pump, it will be configured to work in one of three different ways:

- 1, The circ pump operates continuously (24 hours) with the exception of turning off for 30 minutes at a time when the water temperature reaches 3°F (1.5°C) above the set temperature (most likely to happen in very hot climates).
- 2, The circ pump stays on continuously, regardless of water temperature.
- 3, A programmable circ pump will come on when the system is checking temperature (polling), during filter cycles, during freeze conditions, or when another pump or blower is on.

The specific Circulation Mode that is used has been determined by the Manufacturer and cannot be changed in the field.

Filtration and Ozone

On non-circ systems, Pump 1 low and the ozone generator will run during filtration. On circ systems, the ozone will run with the circ pump.

The system is factory-programmed with one filter cycle that will run in the evening (assuming the time-of-day is properly set) when energy rates are often lower. The filter time and duration are programmable. (See page 10)

A second filter cycle can be enabled as needed.

At the start of each filter cycle, all water devices (other than the primary pump) will run briefly to purge the plumbing to maintain good water quality. The term "water devices" includes the Blower.

Freeze Protection

If the temperature sensors within the heater detect a low enough temperature, then the pump(s) and the blower automatically activate to provide freeze protection. The pump(s) and blower will run either continuously or periodically depending on conditions.

In colder climates, an optional freeze sensor may be added to protect against freeze conditions that may not be sensed by the standard sensors. Auxiliary freeze sensor protection acts similarly except with the temperature thresholds determined by the switch. See your dealer for details.

Clean-up Cycle (optional)

When a pump or blower is turned on by a button press, a clean-up cycle begins 30 minutes after the pump or blower is turned off or times out. The pump and the ozone generator will run for 30 minutes or more, depending on the system. On some systems, you can change this setting. (See the Preferences section on page 12)

Manufactured under one or more of these patents. U.S. Patents: 5332944, 5361215, 5560753, 5566720, 5,863,458, 6253227, 6262370, 6990198, 6976052, 6365815, 7030343, 7,417,834 b2, Canadian Patent: 2342814, Australian patent: 2373248 other patents both foreign and domestic applied for and pending. All material copyright of Balboa Water Group.

BALBOA
water group

Temperature and Temp Range

Adjusting the Set Temperature

When using a panel with Up and Down buttons (Temperature buttons), pressing Up or Down will cause the temperature to flash. Pressing a temperature button again will adjust the set temperature in the direction indicated on the button. When the LCD stops flashing, the spa will heat to the new set temperature when required.

If the panel has a single temperature button, pressing the button will cause the temperature to flash. Pressing the button again will cause the temperature to change in one direction (e.g. UP). After allowing the display to stop flashing, pressing the Temperature Button will cause the temperature to flash and the next press will change the temperature in the opposite direction (e.g. DOWN).

Press-and-Hold

If a Temperature button is pressed and held when the temperature is flashing, the temperature will continue to change until the button is released. If only one temperature button is available and the limit of the Temperature Range is reached when the button is being held, the progression will reverse direction.

Dual Temperature Ranges

This system incorporates two temperature range settings with independent set temperatures. The High Range designated in the display by a thermometer and an "up" arrow, and the Low Range designated in the display by a thermometer and "down" arrow.

These ranges can be used for various reasons, with a common use being a "ready to use" setting vs. a "vacation" setting. The Ranges are chosen using the menu structure below. Each range maintains its own set temperature as programmed by the user. This way, when a range is chosen, the spa will heat to the set temperature associated with that range.

For example:

High Range might be set between 80°F and 104°F.

Low Range might be set between 50°F and 99°F.

More specific Temp Ranges may be determined by the Manufacturer.

Freeze Protection is active in either range.

See Ready and Rest on Page 6

for additional heating control information.

Key

- █ Indicates Flashing or Changing Segment
- █ Indicates Alternating or Progressive Message - every 1/2 second
- ⏏ A temperature button, used for "Action"
- ☰ Menu/Select button
- Waiting time that keeps the last change to a menu item.
- ***** Waiting time (depends on menu item) that reverts to original setting and ignores any change to that menu item.

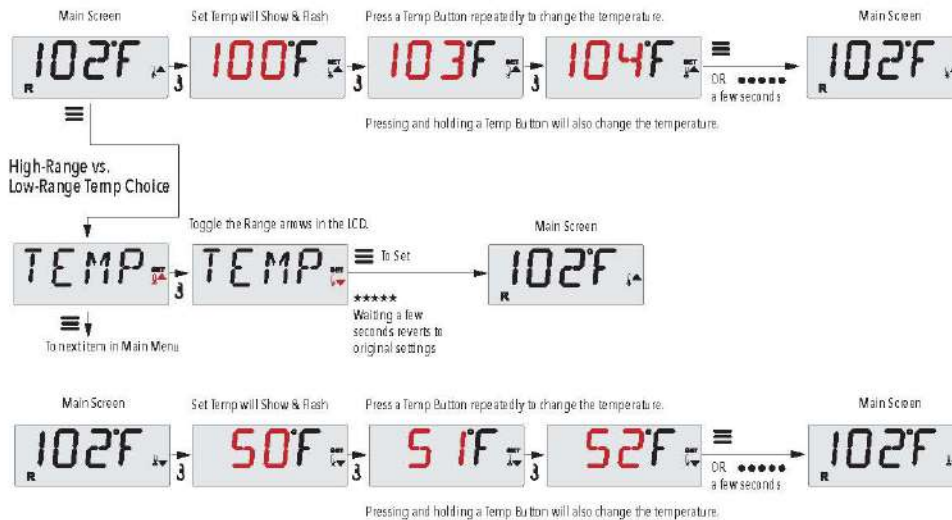

Manufactured under one or more of these patents: U.S. Patents: 5332944, 5361215, 5590753, 5669720, 5,883,459, 6253227, 6282370, 6590499, 6676052, 6965815, 7030348, 7,417,834 b2, Canadian Patent: 2342614, Australian patent: 2373248 other patents both foreign and domestic applied for and pending. All material copyright of Balboa Water Group.



Mode – Ready and Rest

In order for the spa to heat, a pump needs to circulate water through the heater. The pump that performs this function is known as the "primary pump."

The primary pump can be either a 2-Speed Pump 1 or a circulation pump.

If the primary pump is a 2-Speed Pump 1, Ready Mode (indicated by **R**) will circulate water periodically, using Pump 1 Low, in order to maintain a constant water temperature, heat as needed, and refresh the temperature display. This is known as "polling."

Rest Mode (indicated by **☒**) will only allow heating during programmed filter cycles. Since polling does not occur, the temperature display may not show a current temperature until the primary pump has been running for a minute or two.

Circulation Mode (See Page 4, under Pumps, for other circulation modes)

If the spa is configured for 24HR circulation, the primary pump generally runs continuously. Since the primary pump is always running, the spa will maintain set temperature and heat as needed in Ready Mode, without polling.

In Rest Mode, the spa will only heat to set temperature during programmed filter times, even though the water is being filtered constantly when in Circulation Mode.

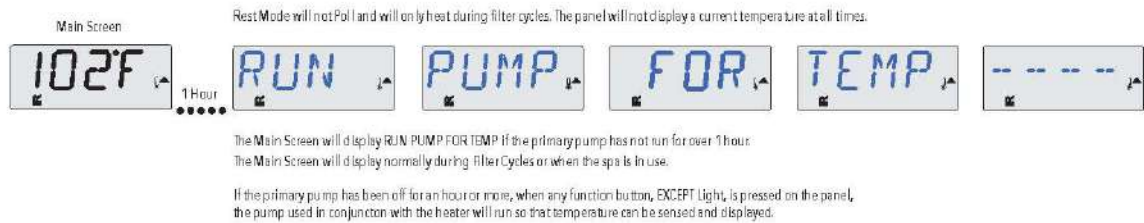
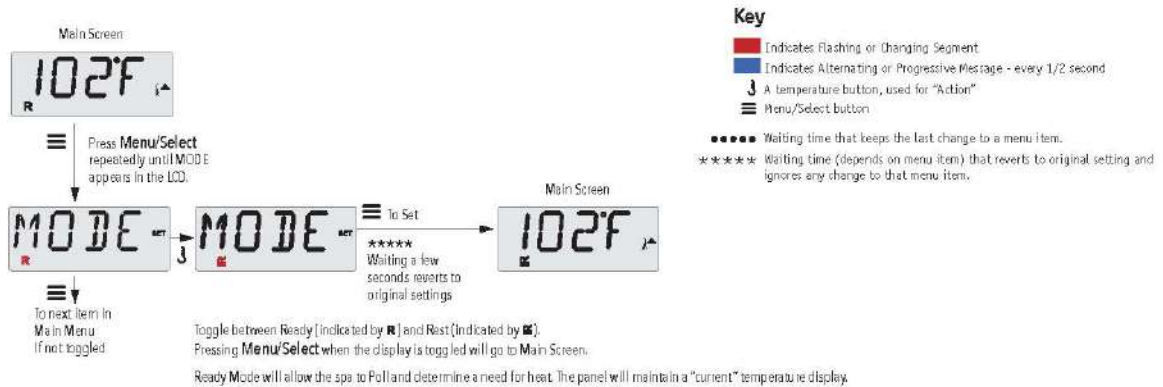

Ready-in-Rest Mode

R☒ appears in the display if the spa is in Rest Mode and "Jets" is pressed. It is assumed that the spa is being used and will heat to set temperature. The primary pump will run until set temperature is reached, or 1 hour has passed. After 1 hour, the System will revert to Rest Mode. This mode can also be reset by entering the Mode Menu and changing the Mode.

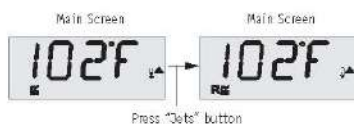

Manufactured under one or more of these patents. U.S. Patents: 5332044, 5361215, 5560753, 5569720, 5 883,450, 6253227, 6082370, 6501188, 6976052, 6965815, 7030343, 7,417,834 b2, Canadian Patent: 2342614, Australian patent: 2373248 other patents both foreign and domestic applied for and pending. All material copyright of Balboa Water Group.



Show and Set Time-of-Day

Be sure to set the Time-of-Day

Setting the time-of-day can be important for determining filtration times and other background features.

When in the TIME menu, SET TIME will flash on the display if no time-of-day is set in the memory.

24-hour time display can be set under the PREF menu. (See Page 12)

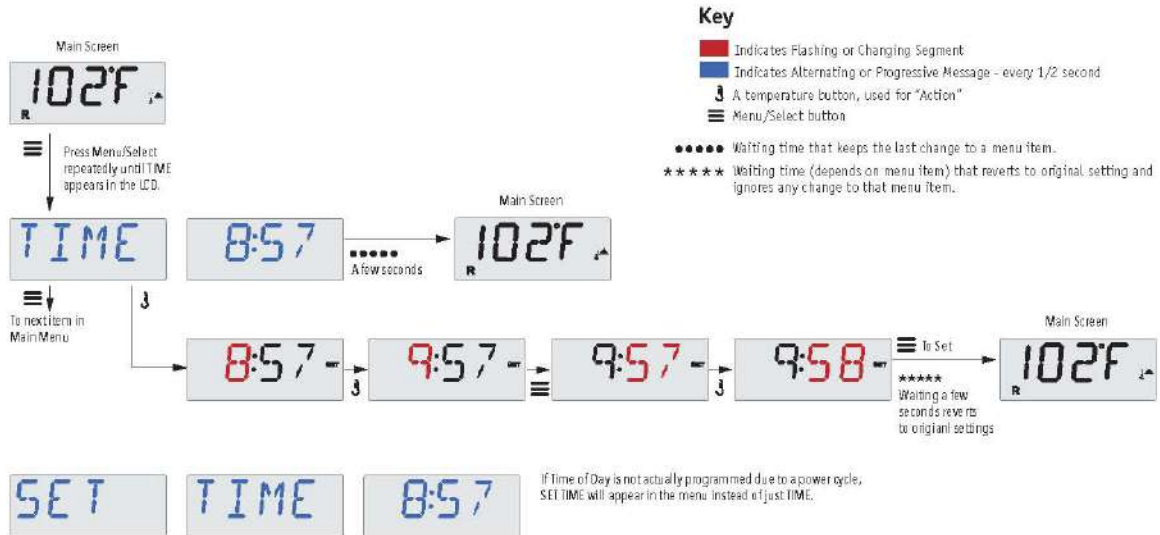

Note:

This note refers to systems that do not keep track of Time-of-Day when powered down.

If power is interrupted to such a system, Time-of-Day is not stored. The system will still operate and all other user settings will be stored. If filter cycles are required to run at a particular time of day, resetting the clock will return the filter times to the actual programmed periods.

When such a system starts up, it defaults to 12:00 Noon, so another way to get filter times back to normal is to start up the spa at noon on any given day. SET TIME will still flash in the TIME Menu until the time is actually set, but since the spa started at noon, the filter cycles will run as programmed.

Flip (Invert Display)

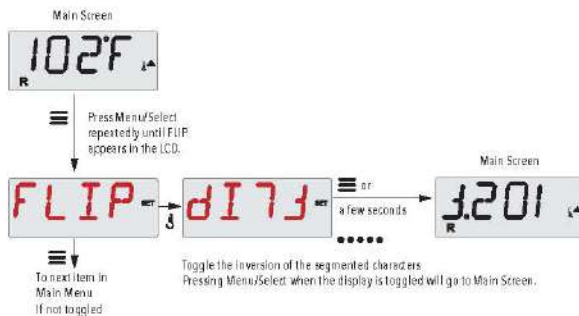

Manufactured under one or more of these patents. U.S. Patents: 5332944, 5361215, 5590753, 5569720, 5,883,459, 6253227, 6282370, 6590188, 6976052, 6965815, 7030343, 7,417,834 b2, Canadian Patent: 2342614, Australian patent: 2373248 other patents both foreign and domestic applied for and pending. All material copyright of Balboa Water Group.

BALBOA
water group

Restricting Operation

The control can be restricted to prevent unwanted use or temperature adjustments.

Locking the panel prevents the controller from being used, but all automatic functions are still active.

Locking the Temperature allows Jets and other features to be used, but the Set Temperature and other programmed settings cannot be adjusted.

Temperature Lock allows access to a reduced selection of menu items. These include Set Temperature, FLIP, LOCK, UTIL, INFO and FALT LOG.

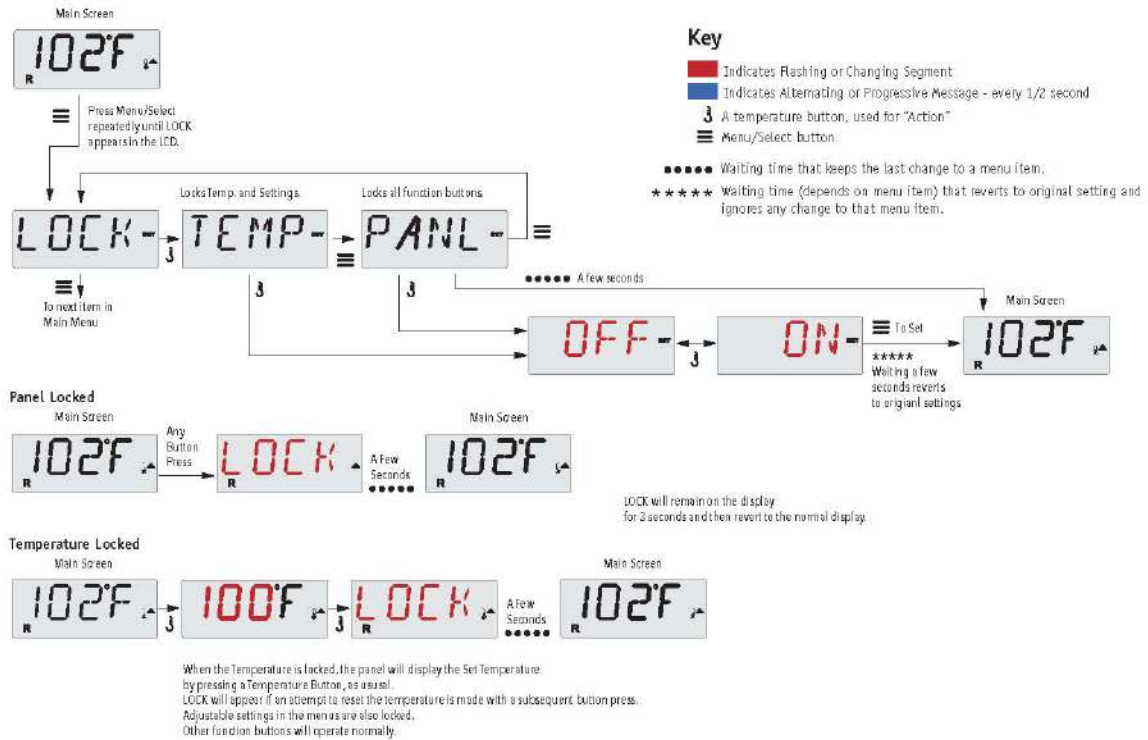

Unlocking

This Unlock sequence may be used from any screen that may be displayed on a restricted panel.



NOTE: If the panel has both an UP and a Down button, the ONLY button that will work in the Unlock Sequence is the UP button.

The temperature will not Unlock if the Unlock sequence is done while the panel is displaying "LOCK".

Manufactured under one or more of these patents: U.S. Patents: 5332944, 5361215, 5550753, 5556720, 5,983,450, 6252227, 6262370, 6560199, 6378052, 6965815, 7030343, 7,417,834 b2, Canadian Patent: 2342614, Australian patent: 2373248 other patents both foreign and domestic applied for and pending. All material copyright of Balboa Water Group.



Hold (Standby)

Hold Mode –M037*

Hold Mode is used to disable the pumps during service functions like cleaning or replacing the filter. Hold Mode will last for 1 hour unless the mode is exited manually.

Drain Mode

Some spas have a special feature that allows a pump to be employed when draining the water.

When available, this feature is a component of Hold Mode.

Drain Mode will time out with Hold Mode.

Key

- Indicates Flashing or Changing Segment
- Indicates Alternating or Progressive Message – every 1/2 second
- ⏏ A temperature button, Used for "Action"
- ☰ Menu/Select button

- Waiting time that keeps the last change to a menu item.
- ***** Waiting time (depends on menu item) that reverts to original setting and ignores any change to that menu item.

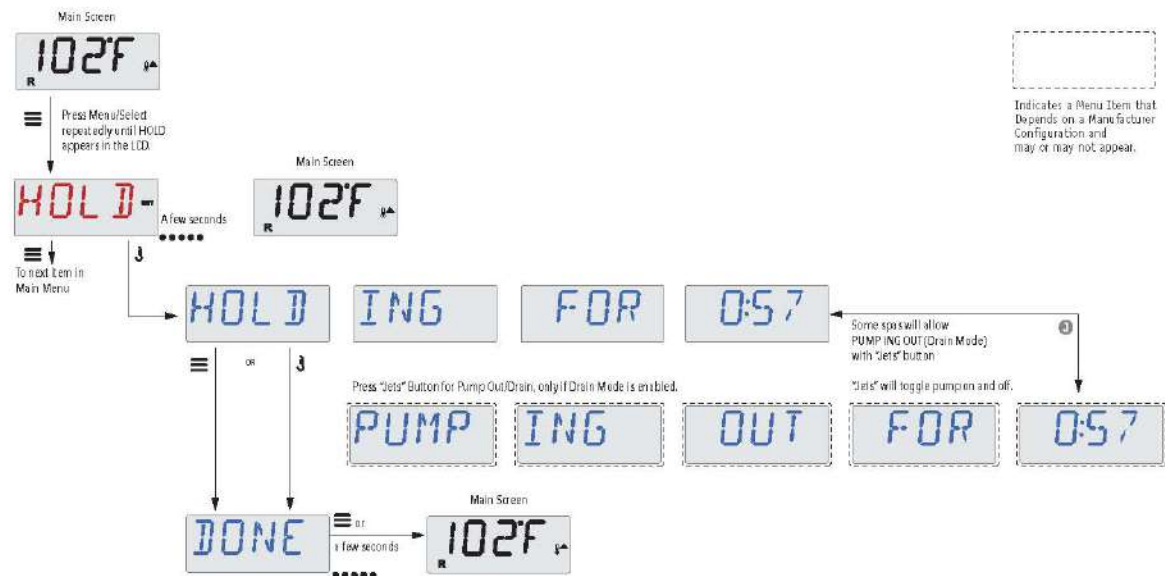

M037 is a Message Code. See Page 18.



Manufactured under one or more of these patents: U.S. Patents: 5332944, 5361215, 5550753, 5556720, 5,983,450, 6252227, 6262370, 6560199, 6878052, 6965815, 7030343, 7,417,834 b2, Canadian Patent: 2342614, Australian patent: 2373248 other patents both foreign and domestic applied for and pending. All material copyright of Balboa Water Group.



Adjusting Filtration

Main Filtration

Filter cycles are set using a start time and a duration. Start time is indicated by an "A" or "P" in the bottom right corner of the display. Duration has no "A" or "P" indication. Each setting can be adjusted in 15-minute increments. The panel calculates the end time and displays it automatically.

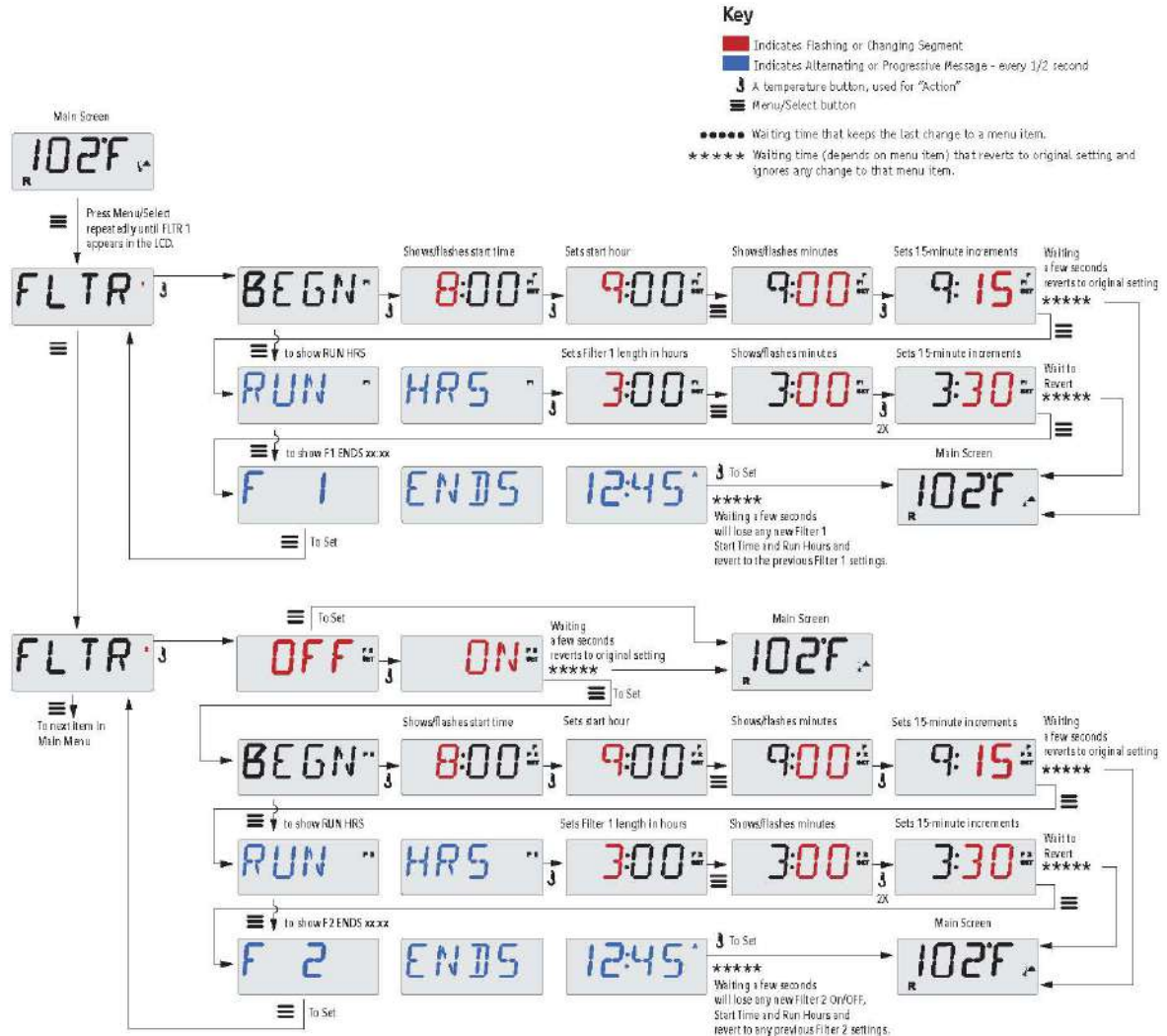

Filter Cycle 2 - Optional Filtration

Filter Cycle 2 is OFF by default.

It is possible to overlap Filter Cycle 1 and Filter Cycle 2, which will shorten overall filtration by the overlap amount.

Purge Cycles

In order to maintain sanitary conditions, secondary Pumps and/or a Blower will purge water from their respective plumbing by running briefly at the beginning of each filter cycle.

If Filter Cycle 1 is set for 24 hours, enabling Filter Cycle 2 will initiate a purge when Filter Cycle 2 is programmed to begin.

Manufactured under one or more of these patents: U.S. Patents: 5332944, 5361215, 5660753, 5959720, 5,883,469, 6253227, 6252370, 6690188, 6876052, 6065915, 7000343, 7,417,834 b2, Canadian Patent: 2342614, Australian patent: 2373248 other patents both foreign and domestic applied for and pending. All material copyright of Balboa Water Group.



Light Timer Programming

Light Timer Option

If LITE TIMR does not appear in the Main Menu, the Light Timer feature is not enabled by the manufacturer.

When available, the Light Timer is OFF by default.

Key

- Indicates Flashing or Changing Segment
- Indicates Alternating or Progressive Message - every 1/2 second
- ⏏** A temperature button, used for "Action"
- ☰** Menu/Select button

- Waiting time that keeps the last change to a menu item.
- ***** Waiting time (depends on menu item) that reverts to original setting and ignores any change to that menu item.

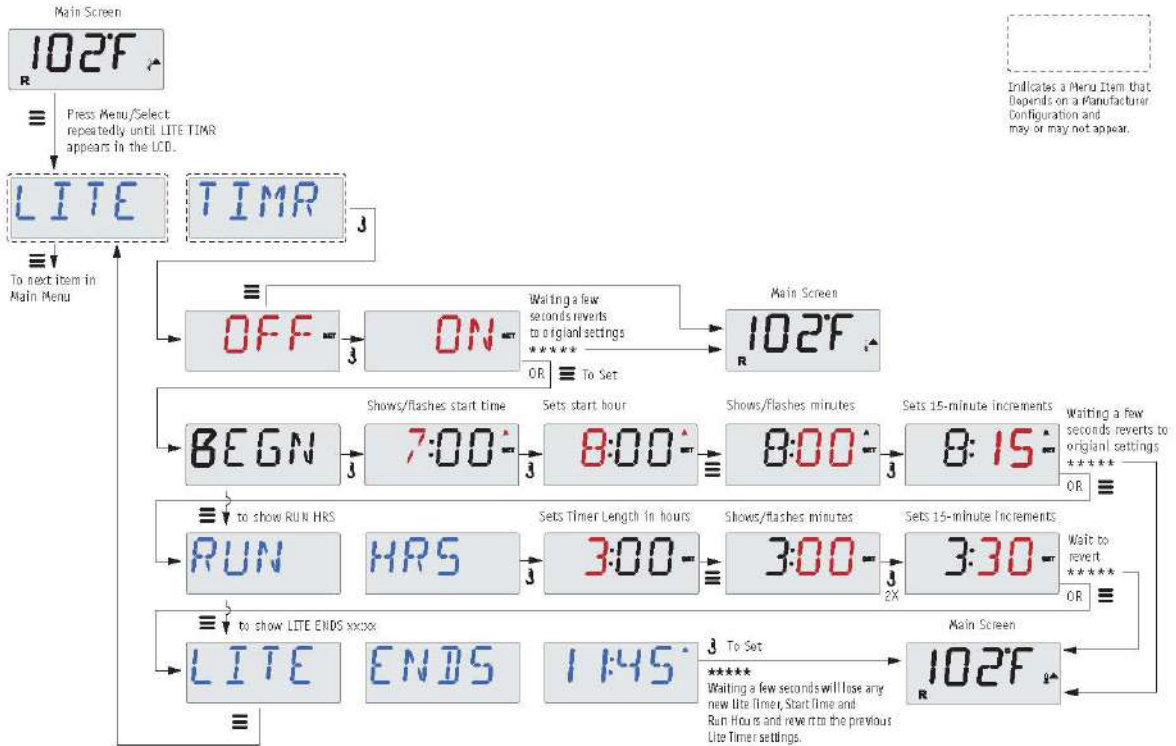

Manufactured under one or more of these patents: U.S. Patents: 5332944, 5361215, 5550753, 5558720, 5,883,458, 6263227, 6282370, 6590188, 6947662, 6965815, 7030343, 7,417,834 B2, Canadian Patent: 2348514, Australian patent: 2373248 other patents both foreign and domestic applied for and pending. All material copyright of Balboa Water Group.



Preferences

F / C (Temp Display)

Change the temperature between Fahrenheit and Celsius.

12 / 24 (Time Display)

Change the clock between 12 hr and 24 hr display.

RE-MIN-DERS (Reminders)

Turn the display of reminder messages (like "Clean Filter") On or Off.

Note: Reminders continue to run in the background even when not displayed. So turning the display of Reminders On or Off does not reset any Reminder counts.

CLN-UP (Cleanup)

Cleanup Cycle Duration is not always enabled, so it may not appear. When it is available, set the length of time Pump 1 will run after each use. 0-4 hours are available.

M8

(This message may not appear on all systems.) On systems that have M8, it is enabled by default. It can be disabled (or re-enabled) here. M8 reduces polling intervals when the water temperature in the spa is steady.

DOL-PHIN-AD-DRES (Dolphin II and Dolphin III) Applies to RF Dolphin only.

(This message may not appear depending on the configuration)

When set to 0, no addressing is used. Use this setting for a Dolphin Remote which is factory set for no address by default. When set between 1 and 7, the number is the address. (See the Dolphin manual for details.)

Manufactured under one or more of these patents: U.S. Patents: 5332944, 5361215, 5660753, 5959720, 5,883,469, 6253227, 6262370, 6690188, 6876052, 6965915, 7000343, 7,417,834 b2, Canadian Patent: 2342614, Australian patent: 2373248 other patents both foreign and domestic applied for and pending. All material copyright of Balboa Water Group.

BALBOA
water group

Preferences

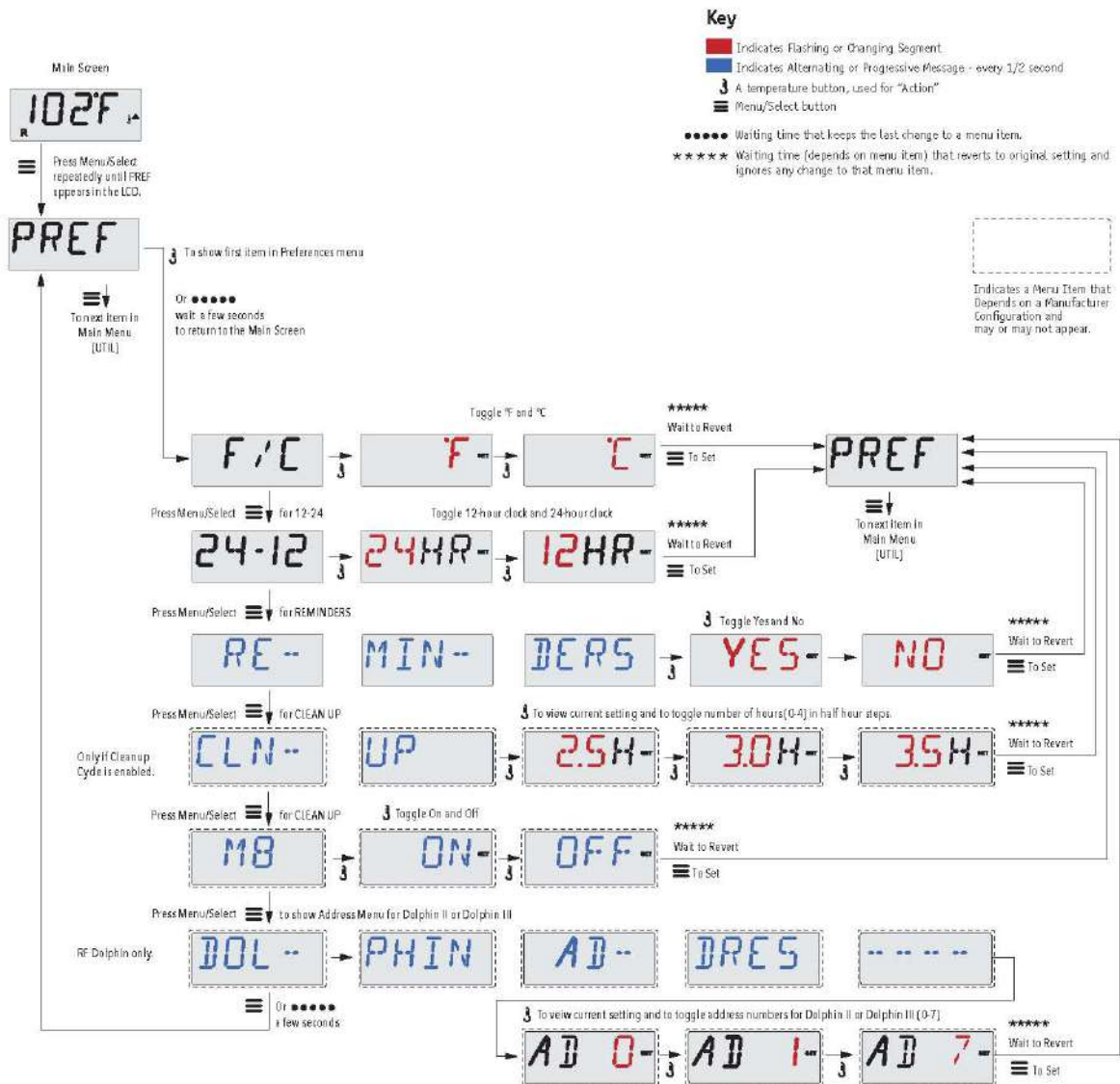

Manufactured under one or more of these patents: U.S. Patents: 5332944, 5361215, 5550753, 5558720, 5,883,458, 6253227, 6282370, 6530188, 6947602, 6965845, 7030343, 7,417,834 b2, Canadian Patent: 2348814, Australian patent: 2373248 other patents both foreign and domestic applied for and pending. All material copyright of Balboa Water Group.



Utilities and Information

INFO (System Information sub-menu)

The System Information Menu displays various settings and identification of the particular system.

SSID (Software ID)

Displays the software ID number for the System.

MODL (System Model)

Displays the Model Number of the System.

SETP (Current Setup)

Displays the currently selected Configuration Setup Number.

Heater Voltage (Feature not used on CE rated systems.)

Displays the operating voltage configured for the heater.

Heater Wattage as Configured in Software (CE Systems Only.)

Displays a heater kilowatt rating as programmed into the control system software (1-3 or 3-6).

H_ (Heater Type)

Displays a heater type ID number.

SW_ (Dip Switch Settings)

Displays a number that represents the DIP switch positions of S1 on the main circuit board.

PANL (Panel Version)

Displays a number of the software in the topside control panel.

Manufactured under one or more of these patents. U.S. Patents: 5332944, 5361215, 5560753, 5569720, 5,883,459, 6253227, 6282370, 6590188, 6976052, 6965815, 7030343, 7,417,634 b2. Canadian Patent: 2342614, Australian patent: 2373248 other patents both foreign and domestic applied for and pending. All material copyright of Balboa Water Group.

BALBOA
water group

Additional Utilities

Utilities

In addition to INFO, The Utilities Menu contains the following:

GFCI (GFCI Test)

(Feature not available on CE rated systems.)

GFCI Test is not always enabled, so it may not appear. This screen allows the GFCI to be tested manually from the panel and can be used to reset the automatic test feature. If the GFCI Test Feature is reset, the device will trip within 7 days. (See Page 17)

A / B (A/B Sensor Temperatures)

When this is set to On, the temperature display will alternate to display temperature from Sensor A and Sensor B in the heater.

FALT LOG (Fault Log)

The Fault Log is a record of the last 24 faults that can be reviewed by a service tech.

DEMO (Demo Mode)

Demo Mode is not always enabled, so it may not appear. This is designed to operate several devices in a sequence in order to demonstrate the various features of a particular hot tub.

Manufactured under one or more of these patents: U.S. Patents: 5332944, 5361215, 5550753, 5556720, 5,983,450, 6252227, 6262370, 6560199, 6378052, 6965815, 7030343, 7,417,834 b2, Canadian Patent: 2342514, Australian patent: 2373248 other patents both foreign and domestic applied for and pending. All material copyright of Balboa Water Group.

BALBOA
water group

Utilities

Key

- Indicates Flashing or Changing Segment
- Indicator Alternating or Progressive Message - every 1/2 second
- 3** A temperature button, used for "Action"
- ≡** Menu/Select button
- Waiting time that keeps the last change to a menu item.
- ***** Waiting time (depends on menu item) that reverts to original setting and ignores any change to that menu item.

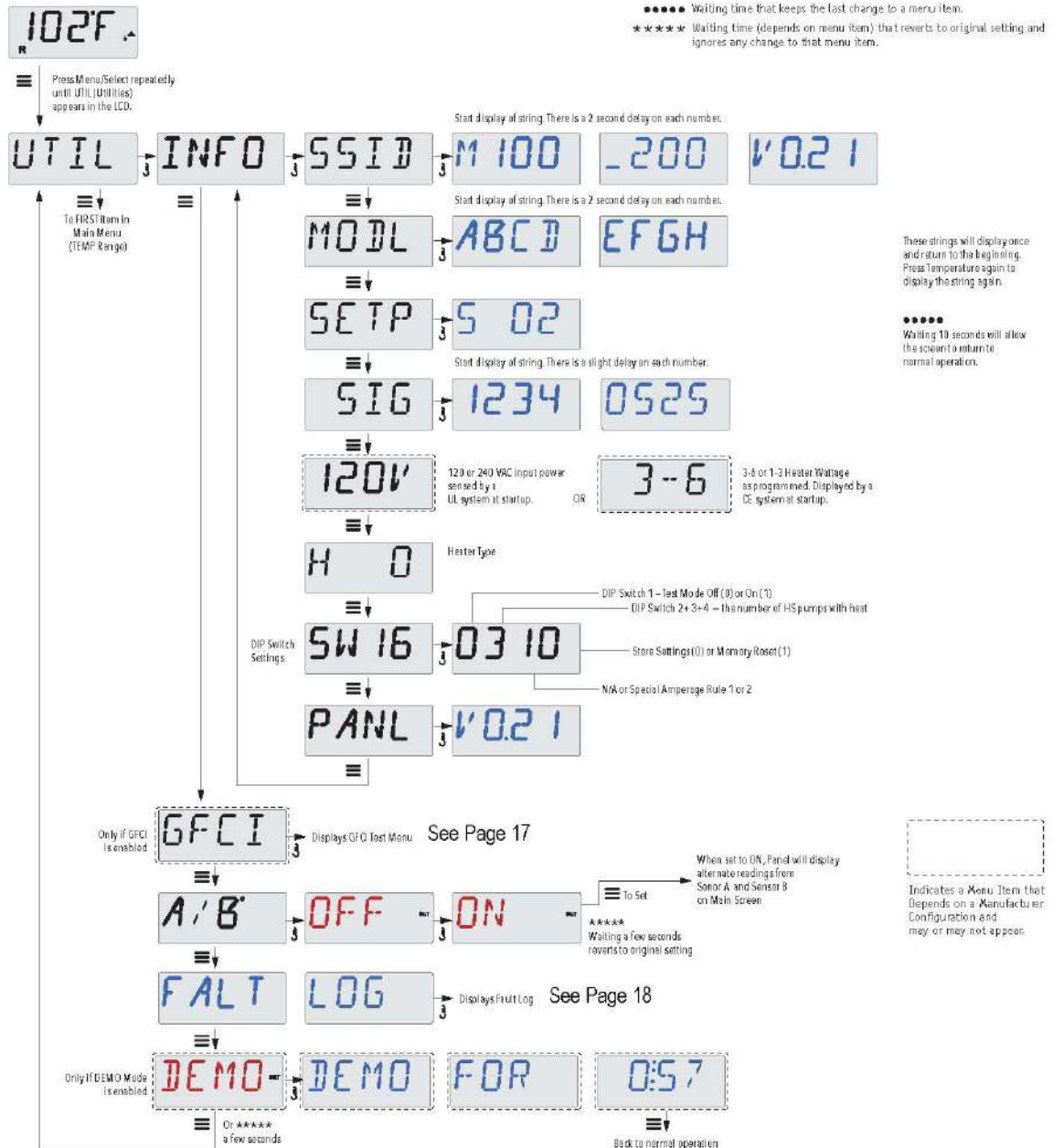

These strings will display once and return to the beginning. Press temperature again to display the string again.

..... Waiting 10 seconds will allow the screen to return to normal operation.

Indicates a Menu Item that Depends on a Manufacturer Configuration and may or may not appear.

Manufactured under one or more of these patents. U.S. Patents: 5332944, 5361215, 5560753, 5566720, 5,883,458, 6253227, 6262370, 6990198, 6976052, 6365815, 7030343, 7,417,834 b2, Canadian Patent: 2342814, Australian patent: 2373248 other patents both foreign and domestic applied for and pending. All material copyright of Balboa Water Group.



Utilities – GFCI Test Feature

Not Available on CE Rated Systems.

A GFCI is an important safety device and is required equipment on a hot tub installation.

Your spa may be equipped with a GFCI Protection feature. (UL rated systems only.) If your spa has this feature enabled by the manufacturer, the GFCI Trip Test must occur to allow proper spa function.

Within 1 to 7 days after startup, the spa will trip the GFCI to test it. (The number of days is factory programmed.) The GFCI must be reset once it has tripped. After passing the GFCI Trip Test, any subsequent GFCI trips will indicate a ground fault or other unsafe condition and the power to the spa must be shut off until a service person can correct the problem.

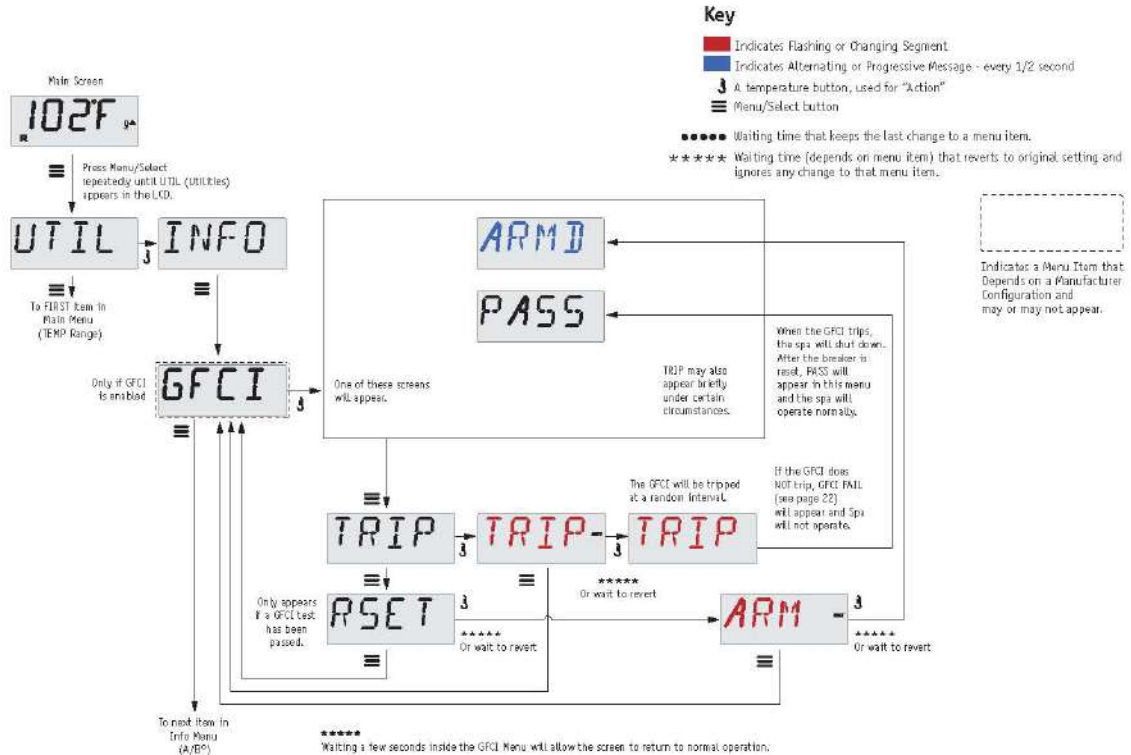

Forcing the GFCI Trip Test

The installer can cause the GFCI Trip Test to occur sooner by initiating it using the above menu.

The GFCI should trip within a few seconds and the spa should shut down. If it does not, shut down the power and manually verify that a GFCI breaker is installed and that the circuit and spa are wired correctly. Verify the function of the GFCI with its own test button. Restore power to the spa and repeat the GFCI Trip Test.

Once the GFCI is tripped by the test, reset the GFCI and the spa will operate normally from that point. You can verify a successful test by navigating to the above menu. PASS should appear after a temp button is pressed from the GFCI screen.

The end-user must be trained to expect this one-time test to occur and how to properly reset the GFCI.

Warning:

If freezing conditions exist, a GFCI should be reset immediately or spa damage could result. The end user should always be trained to test and reset the GFCI on a regular basis.

Manufactured under one or more of these patents: U.S. Patents: 5,332,944; 5,361,215; 5,550,073; 5,559,720; 5,683,459; 6,253,227; 6,282,370; 6,530,188; 6,947,602; 6,965,815; 7,030,343; 7,417,834 b2; Canadian Patent: 23,426,814; Australian patent: 2373248 other patents both foreign and domestic applied for and pending. All material copyright of Balboa Water Group.



Utilities – Fault Log

A Little History can tell a lot

The Fault Log stores up to 24 events in memory and they can be reviewed under the Fault Log Menu.

Each event captures a Fault Message Code, how many days have passed since the fault, Time of the fault, Set Temperature during the fault, and Sensor A and B temperatures during the fault.

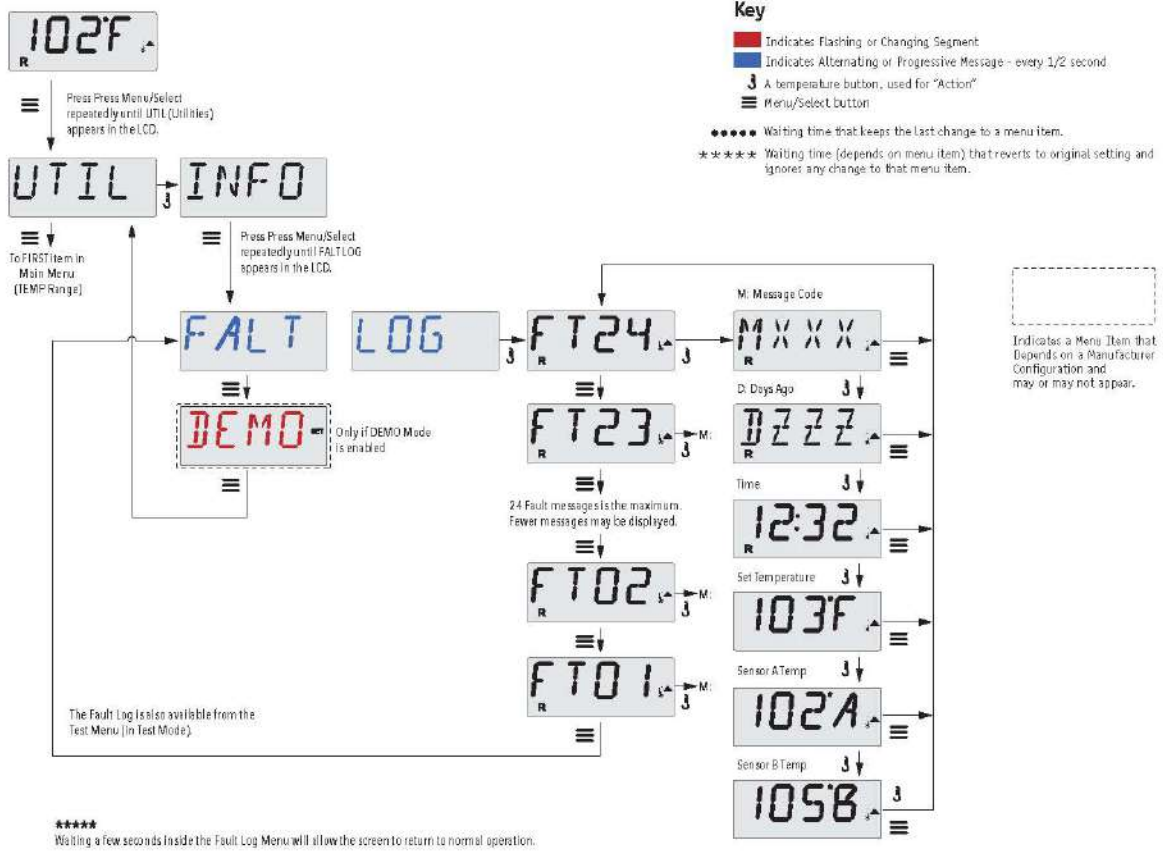

See following pages for various Message Codes and definitions.

Manufactured under one or more of these patents: U.S. Patents: 5332944, 5361215, 5590753, 5569720, 5,893,459, 6253227, 6292370, 6590199, 6676052, 6965815, 7030343, 7,417,834 b2, Canadian Patent: 2342614, Australian patent: 2373248 other patents both foreign and domestic applied for and pending. All material copyright of Balboa Water Group.



General Messages



Priming Mode – MO19

Each time the spa is powered up, it will enter Priming Mode. The purpose of Priming Mode is to allow the user to run each pump and manually verify that the pumps are primed (air is purged) and water is flowing. This typically requires observing the output of each pump separately, and is generally not possible in normal operation. Priming Mode lasts 4 minutes, but you can exit it earlier by pressing any Temp button. The heater is not allowed to run during Priming Mode.

NOTE: If your spa has a Circ Pump, it will turn on with "Light" in Priming Mode. The Circ Pump will run by itself when Priming Mode is exited.



Water Temperature is Unknown

After the pump has been running for 1 minute, the temperature will be displayed.



Too Cold - Freeze Protection

A potential freeze condition has been detected, or the Aux Freeze Switch has closed, and all pumps and blower are activated, either one at a time, or all at once, depending on how your system was built. All pumps and blower are ON for at least 4 minutes after the potential freeze condition has ended, or when the aux freeze switch opens.

In some cases, pumps may turn on and off and the heater may operate during Freeze Protection.

This is an operational message, not an error indication.



Water is too Hot (OHS) – MO29

One of the water temp sensors has detected spa water temp 110°F (43.3°C) and spa functions are disabled. System will auto reset when the spa water temp is below 108°F (42.2°C). Check for extended pump operation or high ambient temp.



J29 Warning – MO44

J29 is typically used as a Heater Disable input. As such, it should not typically be shorted at power-up. This message appears if J29 is shorted at power-up.

MOXX numbers are Message Codes. See Page 18.

* This message can be reset from the topside panel with any button press.

Manufactured under one or more of these patents: U.S. Patents: 5332944, 5381215, 5550753, 5559720, 5,883,459, 6253227, 6262370, 6560198, 6878052, 6965815, 7030343, 7,417,834 b2, Canadian Patent: 2342614, Australian patent: 2373248 other patents both foreign and domestic applied for and pending. All material copyright of Balboa Water Group.



Heater-Related Messages



Heater Flow is Reduced (HFL) – MO16

There may not be enough water flow through the heater to carry the heat away from the heating element. Heater start up will begin again after about 1 min. See "Flow Related Checks" below.



Heater Flow is Reduced (LF)* – MO17

There is not enough water flow through the heater to carry the heat away from the heating element and the heater has been disabled. See "Flow Related Checks" below. After the problem has been resolved, you must press any button to reset and begin heater start up.



Heater may be Dry (dr)* – MO28

Possible dry heater, or not enough water in the heater to start it. The spa is shut down for 15 min. Press any button to reset the heater start-up. See "Flow Related Checks" below.



Heater is Dry* – MO27

There is not enough water in the heater to start it. The spa is shut down. After the problem has been resolved, you must press any button to reset and restart heater start up. See "Flow Related Checks" below.



Heater is too Hot (OHH)* – MO30

One of the water temp sensors has detected 118°F (47.8°C) in the heater and the spa is shut down. You must press any button to reset when water is below 108°F (42.2°C). See "Flow Related Checks" below.



A Reset Message may Appear with other Messages.

Some errors may require power to be removed and restored.

Flow-Related Checks

Check for low water level, suction flow restrictions, closed valves, trapped air, too many closed jets and pump prime.

On some systems even when spa is shut down, some equipment may occasionally turn on to continue monitoring temperature or if freeze protection is needed.

* This message can be reset from the topside panel with any button press.

Manufactured under one or more of these patents: U.S. Patents: 5332944, 5361215, 5590753, 5569720, 5,883,459, 6253227, 6282370, 6590499, 6676052, 6965915, 7030343, 7,417,834 b2, Canadian Patent: 2342614, Australian patent: 2373248 other patents both foreign and domestic applied for and pending. All material copyright of Balboa Water Group.



Sensor-Related Messages

102°F R SN5R BAL-- ANCE R

Sensor Balance is Poor – MO15

The temperature sensors MAY be out of sync by or 3°F. Call for Service.

SN5R R SYNC R --- R CALL R FOR R SRVC R --- R

Sensor Balance is Poor* – MO26

The temperature sensors ARE out of sync. The Sensor Balance is Poor fault has been established for at least 1 hour. Call for Service.

SN5R R A R --- R CALL R FOR R SRVC R --- R

B R

Sensor Failure – Sensor A: MO31, Sensor B: MO32

A temperature sensor or sensor circuit has failed. Call for Service.

Miscellaneous Messages

NO R COMM R

No Communications

The control panel is not receiving communication from the System. Call for Service.

BETA R VER-- R SION R --- R

Pre-Production Software

The Control System is operating with test software. Call for Service.

102°F R

°F or °C is replaced by °T

The Control System is in Test Mode. Call for Service.

* This message can be reset from the topside panel with any button press.

Manufactured under one or more of these patents: U.S. Patents: 5332944, 5361215, 5553763, 5559720, 5,883,469, 6253227, 6282370, 6590188, 6976052, 6966815, 7030343, 7,417,634, 12, Canadian Patent: 2342614, Australian patent: 2373248 other patents both foreign and domestic applied for and pending. All material copyright of Balboa Water Group.

BALBOA
water group

System-Related Messages



Memory Failure - Checksum Error* – MO22

At Power-Up, the system has failed the Program Checksum Test. This indicates a problem with the firmware (operation program) and requires a service call.

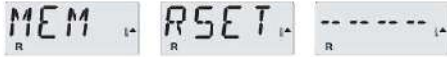

Memory Warning - Persistent Memory Reset* – MO21

Appears after any system setup change. Contact your dealer or service organization if this message appears on more than one power-up, or if it appears after the system has been running normally for a period of time.



Memory Failure - Clock Error* – MO20 - Not Applicable on the BP1500

Contact your dealer or service organization.



Configuration Error – Spa will not Start Up

Contact your dealer or service organization.



GFCI Failure - System Could Not Test/Trip the GFCI – MO36

NORTH AMERICA ONLY. May indicate an unsafe installation. Contact your dealer or service organization.

* This message can be reset from the topside panel with any button press.

Manufactured under one or more of these patents: U.S. Patents: 5332944, 5361215, 5660753, 5959720, 5,883,469, 6253227, 6262370, 6690188, 6876052, 6965915, 7000343, 7,417,834 b2, Canadian Patent: 2342614, Australian patent: 2373248 other patents both foreign and domestic applied for and pending. All material copyright of Balboa Water Group.



System-Related Messages



A Pump Appears to be Stuck ON – MO34

Water may be overheated. POWER DOWN THE SPA. DO NOT ENTER THE WATER. Contact your dealer or service organization.



A Pump Appears to have been Stuck ON when spa was last powered - MO35

POWER DOWN THE SPA. DO NOT ENTER THE WATER.
Contact your dealer or service organization.

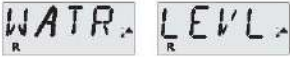

The water level is too low

Some systems have a water level detect, and this message appears if it detects that the water level is too low.

* This message can be reset from the topside panel with any button press.

Manufactured under one or more of these patents: U.S. Patents: 5332944, 5361215, 5550753, 5559720, 5,983,459, 6253227, 6292370, 6590188, 6976052, 6965815, 7030343, 7,417,834 b2, Canadian Patent: 2342614, Australian patent: 2373248 other patents both foreign and domestic applied for and pending. All material copyright of Balboa Water Group.



Reminder Messages

General maintenance helps.

The display of Reminder Messages can be suppressed by using the PREF Menu. See Page 12.

Reminder Messages can be chosen individually by the Manufacturer. They may be disabled entirely, or there may be a limited number of reminders on a specific model.

The frequency of each reminder (e.g. 7 days) can be specified by the Manufacturer.

Press a Temperature button to reset a displayed reminder message.



Alternates with temperature or normal display.

Appears on a regular schedule, e.g. every 7 days.

Check pH with a test kit and adjust pH with the appropriate chemicals.



Alternates with temperature or normal display.

Appears on a regular schedule, e.g. every 7 days.

Check sanitizer level and other water chemistry with a test kit and adjust with the appropriate chemicals.



Alternates with temperature or normal display.

Appears on a regular schedule, e.g. every 30 days.

Clean the filter media as instructed by the manufacturer. See HOLD on page 9.



Alternates with temperature or normal display.

Appears on a regular schedule, e.g. every 30 days.

The Ground Fault Circuit Interrupter (GFCI) or Residual Current Device (RCD) is an important safety device and must be tested on a regular basis to verify its reliability.

Every user should be trained to safely test the GFCI or RCD associated with the hot tub installation.

A GFCI or RCD will have a TEST and RESET button on it that allows a user to verify proper function.

Warning:

If freezing conditions exist, a GFCI or RCD should be reset immediately or spa damage could result.

The end user should always be trained to test and reset the GFCI or RCD on a regular basis.

Manufactured under one or more of these patents: U.S. Patents: 5332944, 5361215, 5550753, 5559720, 5,883,450, 6253227, 6282370, 6590188, 6976052, 6965915, 7030343, 7,417,834 b2, Canadian Patent: 2342814, Australian patent: 2373246 other patents both foreign and domestic applied for and pending. All material copyright of Balboa Water Group.



Reminder Messages Continued



Alternates with temperature or normal display.

Appears on a regular schedule, e.g. every 90 days.

Change the water in the spa on regular basis to maintain proper chemical balance and sanitary conditions.



Alternates with temperature or normal display.

Appears on a regular schedule, e.g. every 180 days.

Vinyl covers should be cleaned and conditioned for maximum life.



Alternates with temperature or normal display.

Appears on a regular schedule, e.g. every 180 days.

Wood skirting and furniture should be cleaned and conditioned per the manufacturers instructions for maximum life.



Alternates with temperature or normal display.

Appears on a regular schedule, e.g. every 365 days.

Filters should be replaced occasionally to maintain proper spa function and sanitary conditions.



Alternates with temperature or normal display.

As needed.

Install new mineral cartridge.



Alternates with temperature or normal display.

Appears on a regular schedule, e.g. every 365 days.

Check your ozone and/or UV generator per your spa manufacture's instructions.



Alternates with temperature or normal display.

Appears on a regular schedule, e.g. every 365 days.

Have a service technician do a check-up on your spa per your spa manufacturer's instructions.

Manufactured under one or more of these patents: U.S. Patents: 5332944, 5381215, 5550753, 5559720, 5,883,459, 6253227, 6262370, 6560198, 6878052, 6965815, 7030343, 7,417,834 b2, Canadian Patent: 2342614, Australian patent: 2373248 other patents both foreign and domestic applied for and pending. All material copyright of Balboa Water Group.



Warning! Qualified Technician Required for Service and Installation

Basic Installation and Configuration Guidelines

Use minimum 6AWG copper conductors only.

Torque field connections between 21 and 23 in lbs.

Readily accessible disconnecting means to be provided at time of installation. Permanently connected.

Connect only to a circuit protected by a Class A Ground Fault Circuit Interrupter (GFCI) or Residual Current Device (RCD) mounted at least 5' (1.52M) from the inside walls of the spa/hot tub and in line of sight from the equipment compartment.

CSA enclosure: Type 2

Refer to Wiring Diagram inside the cover of the control enclosure.

Refer to Installation and Safety Instructions provided by the spa manufacturer.

Warning: People with infectious diseases should not use a spa or hot tub.

Warning: To avoid injury, exercise care when entering or exiting the spa or hot tub.

Warning: Do not use a spa or hot tub immediately following strenuous exercise

Warning: Prolonged immersion in a spa or hot tub may be injurious to your health

Warning: Maintain water chemistry in accordance with the Manufacturers instructions.

Warning: The equipment and controls shall be located not less than 1.5 meters horizontally from the spa or hot tub.

Warning! GFCI or RCD Protection.

The Owner should test and reset the GFCI or RCD on a regular basis to verify its function.

Warning! Shock Hazard! No User Serviceable Parts.

Do not attempt service of this control system. Contact your dealer or service organization for assistance. Follow all owner's manual power connection instructions. Installation must be performed by a licensed electrician and all grounding connections must be properly installed.

CSA Compliance/Conformité

Caution:

- Test the ground fault circuit interrupter or residual current device before each use of the spa.
- Read the instruction manual.
- Adequate drainage must be provided if the equipment is to be installed in a pit.
- For use only within an enclosure rated CSA Enclosure 3.
- Connect only to a circuit protected by a Class A ground fault circuit interrupter or residual current device.
- To ensure continued protection against shock hazard, use only identical replacement parts when servicing.
- Install a suitably rated suction guard to match the maximum flow rate marked.

Warning:

- Water temperature in excess of 38°C may be injurious to your health.
- Disconnect the electrical power before servicing.

Attention:

- Toujours vérifier l'efficacité du disjoncteur différentiel avant d'utiliser différentiel avant d'utiliser le bain.
- Lire la notice technique.
- Lorsque l'appareillage est installé dans une fosse, on doit assurer un drainage adéquat.
- Employer uniquement à l'intérieur d'une clôture CSA Enclosure 3.
- Connecter uniquement à un circuit protégé par un disjoncteur différentiel de Class A.
- Afin d'assurer une protection permanente contre le danger de shock électrique, lors de l'entretien employer seulement des pièces de rechange identiques.
- Les prises d'aspiration doivent être équipées de grilles convenant au débit maximal indiqué.

Avertissement:

- Des températures de l'eau supérieures à 38°C peuvent présenter un danger pour la santé.
- Déconnecter du circuit d'alimentation électrique avant l'entretien.

Warning/Advertisment:

- Disconnect the electric power before servicing. Keep access door closed.
- Déconnecter du circuit d'alimentation électrique avant l'entretien. Garder la porte fermée.

Manufactured under one or more of these patents: U.S. Patents: 5332944, 5361245, 5550753, 5556720, 5,883,458, 6253227, 6282370, 6590188, 6976052, 6965845, 7030343, 7,417,834 b2, Canadian Patent: 2342614, Australian patent: 2373248 other patents both foreign and domestic applied for and pending. All material copyright of Balboa Water Group.

42339 rev.A1

26

03/06/20

BALBOA
water group

SPATOUGH 3 ICON DRIVEN USER GUIDE

spaTouch™ 3

User Guide

Panel Software Version: 1.02 and above (view page 19)



VISIT US ONLINE
www.BalboaWaterGroup.com



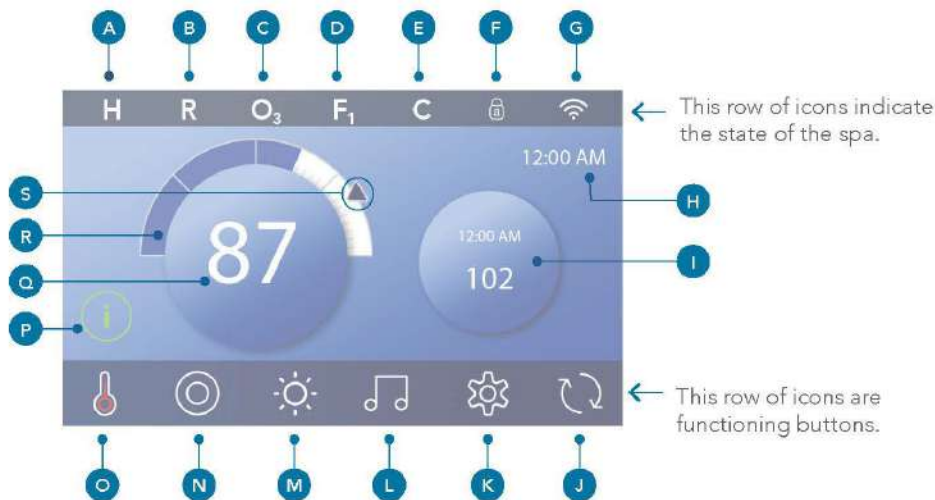

TABLE OF CONTENTS

THE MAIN SCREEN	04
WAKE UP THE PANEL, NAVIGATION & COMMON BUTTONS	06
SET TIME-OF-DAY	09
SET THE TEMPERATURE	10
RUN SPA DEVICES	12
SET FILTER CYCLE TIME	13
RESTRICT OPERATIONS	15
SPA BEHAVIOR	17
DIAGNOSTICS SCREEN	19
HEAT SETTINGS	22
SETTINGS SCREEN	24
FILL IT UP!	26
MESSAGES	27
TOPSIDE PANEL INSTALLATION	30
APPENDIX	31
WARNING	32
INFORMATION	33

THE MAIN SCREEN





Main Screen Icons

- A** - Temperature Range
High: **H**
Low: **L**
- B** - Heat Mode
Ready: **R**
Rest: **E**
Ready-in-Rest: **RR**
- C** - Ozone Running: **O₃**
- D** - Filter Cycles
Filter Cycle 1: **F₁**
Filter Cycle 2: **F₂** (Optional Feature)
Filter Cycles 1 & 2: **F+**
- E** - Cleanup Cycle (Optional Feature)
- F** - Panel Locked and/or Settings Locked
- G** - WiFi (Local or Cloud Connection)
- H** - Time-of-Day
- I** - Secondary Button/Display
- J** - Invert Display
- K** - Settings
- L** - bba™ versions 2 and 3 (Balboa Bluetooth Audio)
- M** - Light (or CHROMAZONE™  if installed).
Both icons change from white to color when these devices are powered On.
- N** - Spa
- O** - Heater Status
- P** - Message Button (May Appear)
Information: 
Reminder: 
Error - Normal Error or Warning: 
Error - Spa will not function until fixed: 
- Q** - Water Temperature
- R** - Water Temperature Bar
- S** - Set Temperature Arrow

The system configuration determines the number of icons that appear on the Main Screen. Your Main Screen may have fewer or different icons.

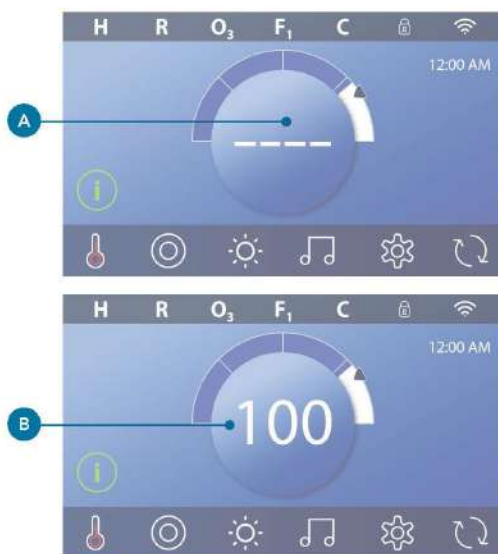
Spa Status



Important information about spa operations can be seen on the Main Screen. Most features, including Set Temperature adjustment, can be accessed from this screen. The actual water temperature can be seen, and the Set Temperature can be adjusted (see page 10). Time-of-Day, Ozone and Filter status are available, along with other messages and alerts. The selected Temperature Range is indicated in the upper left corner. A Lock icon  is visible if the Panel and/or Settings are locked. Near the bottom of the screen, at certain times an indicator may appear showing that a message is waiting. Touch this indicator to go to the Message Display Screen. On that Screen some of the messages can be dismissed. For more on the Message Display Screen, see page 27.

When the spa is powered On, four dashes appear (A) in the Water Temperature display for one minute. The dashes indicate that the spa is checking the water temperature. After the pump runs for 1 minute, the dashes disappear and the water temperature is displayed (B). The dashes may reappear after the pump has not run for one hour.

WAKE UP THE PANEL, NAVIGATION & COMMON BUTTONS

Controlling your spa is easy with the intuitive graphical user interface (GUI). This section describes how to navigate and use the GUI.

Wake Up the Panel

The screen is blank when it is in sleep mode. When you touch the blank screen, this screen appears (A). Wake up the panel by pressing the hand icon (A) and then swiping in the direction of the arrows.

The panel automatically goes into sleep mode when it is not used for 1 minute. The 1 minute duration can be adjusted (view Panel [☰](#) on page 25).

Buttons

A variety of button styles provide quick access to functions and settings. The large temperature display is a button (B) that controls the Set Temperature. The whole bottom row of the Main screen contains buttons (C).

Mini Player Button (Set Temperature/Time)

The Mini Player button gives fast access to the Set Temperature and time (D). Show or hide the Mini Player button by pressing the Heater Status button once (E).

Mini Player Button (Music)

The Mini Player displays music controls (F), if your spa is equipped with bba™ (Balboa Bluetooth Audio) and it is activated. Hide the Mini Player button by pressing the Heater Status button twice (G). The first press displays the Set Temperature/Time Mini Player button. The second press hides the Mini Player button.

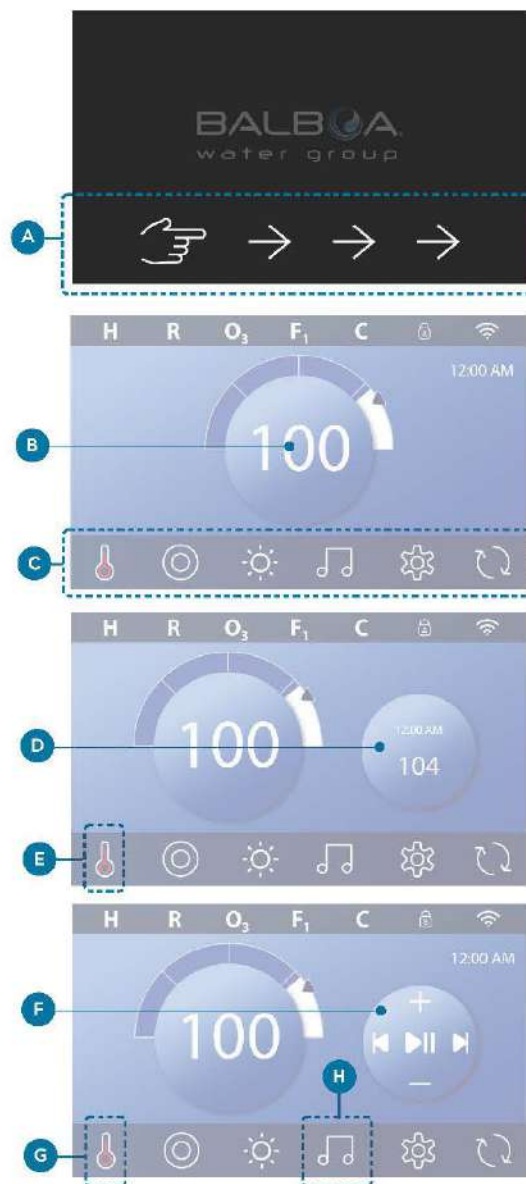

bba™ button (H)

If bba™ is activated, pressing the bba™ button (H) once displays the Mini Player (F) with music controls. Pressing the bba™ button (H) a second time opens the Music screen (I). If bba™ is activated, a white ring appears around the button, as shown here (I).

If bba™ is not activated, pressing the bba™ button (H) once opens the Music screen (I).

If your spa is equipped with bba™, refer to the bba™ user guide that came with the spa. If a user guide was not included, please contact the spa dealer or spa manufacturer.

Screen Names

Screen names appear in the top row of the screen. For example, this is the Settings screen (J). Screen names are referenced throughout this user guide.

Navigation

Navigate screens and/or lists with the following buttons:

- ▲ Up
- ▼ Down
- ↶ Left (K)
- ↷ Right (K)
- ↶ Back (L).

Swiping & Selecting Items in Lists

Swipe a list (N) to find the setting you want. The list will have an arrow (M) that indicates the current setting. If your desired setting appears but is not aligned with the arrow, tap the desired setting to make it align with the arrow. The temperature list will disappear when you tap anywhere outside of it.



Saving & Canceling







After you input a new setting, press the Save button (B). After you press Save, the change is complete. If you don't want to apply a new setting, press the Cancel button (A).

Message Buttons

Message buttons provide reminders to help you keep your spa running smoothly. Message buttons also provide warning information that helps spa technicians with troubleshooting.

When a message button appears (C), press it to view the corresponding message (D) or (G). Press the Exit button (E) to go back to the Main screen, or press the Clear button (F) to dismiss the message.

Buttons vary depending on the type of message. View the list below.

-  Information Message
-  Reminder Message
-  Error - Normal Error or Warning
-  Error - Spa will not function until fixed
-  Clear Button
-  Exit Button

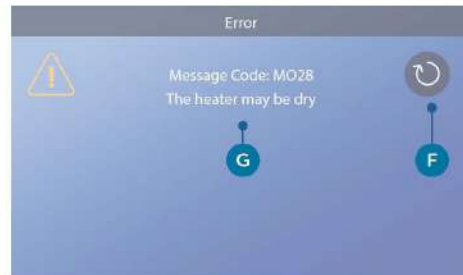
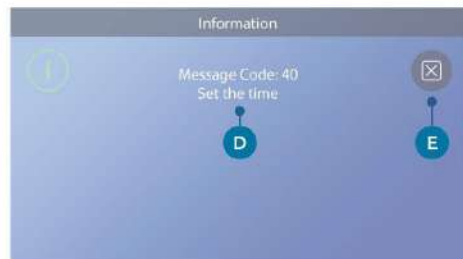

SET THE TIME-OF-DAY

Be sure to set the Time-of-Day

Follow this sequence to set the time-of-day.

- In the Main screen, press the Settings button (B).
- In the Settings screen, press the Time button (C).
- In the Time of Day screen, press the Time button (D).
- Setting dials appear. Swipe these dials (F) to set the time. If your desired time value appears but is not aligned with the arrow, tap the desired time value to make it align with the arrow.
- Press the Save button (G) to save your settings. Or, press the Cancel button (E) to cancel your settings.

Setting the time-of-day is important for determining filtration times and other background features. If Time-of-Day needs to be set, the Information Message button (A) appears on the Main screen; view the previous page for more information on the different types of Message buttons.

NOTE: If power is interrupted to the system, Time-of-Day will be maintained for several days (this only applies to some systems).

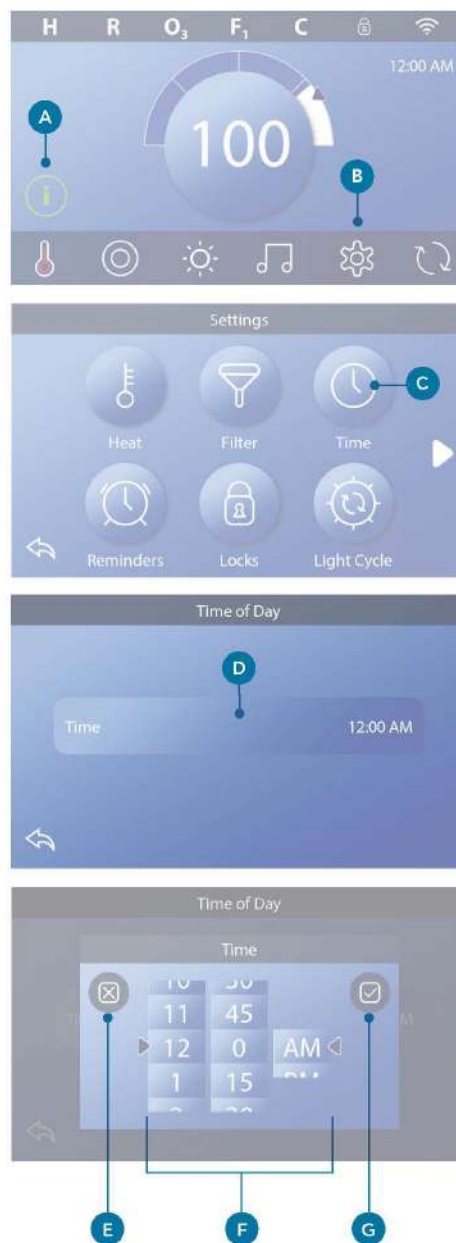

SET THE TEMPERATURE

In this example we will set the Set Temperature to 102.

- Press the water temperature display button (A) to make the temperature menu appear (B). The center box with the arrow (C) indicates the current Set Temperature.
- If 102 is already showing, but just not centered (D), touch it to center it (E).
- If 102 is not showing (B), swipe the temperature menu until 102 appears (D).
- If 102 appears after swiping but does not stop in the center box (D), press 102. Pressing 102 makes it shift to the center box (E).
- Press the water temperature display (A) to make the temperature menu disappear. The Set Temperature is now 102.

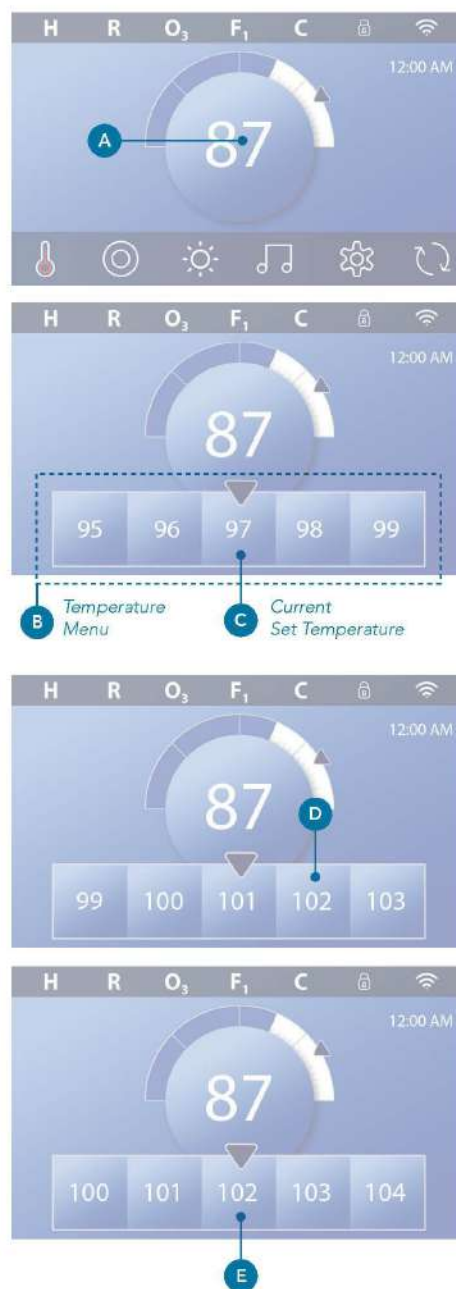

How do I view the Set Temperature?

Press the Heater Status button  (A), and the Set Temperature appears in the Mini Player button (B). Press the Heater Status button again to make the Mini Player button disappear.

Set Temperature is represented numerically and by a blue arrow (D). Water temperature is represented numerically and by a blue status bar (C). The difference between water temperature and Set Temperature is represented by the gap between the blue status bar and the blue arrow (E). If there is no gap, the water temperature and Set Temperature are equal.

Can I change the Set Temperature with the mini player button?

Yes you can. The mini player button and temperature display button function the same way in this regard. Press the mini player button to view the temperature menu. Select the desired temperature, and press the mini player button again to make the temperature menu disappear. You have now programmed a new Set Temperature.

How do I know when the heater is On?

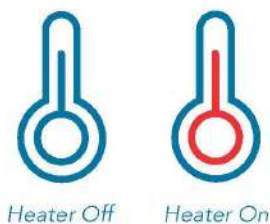

The center of the Heater Status icon  turns red (A) when the heater is On. The Heater Status icon appears in the top left corner of the Spa screen (F) when the heater is On.

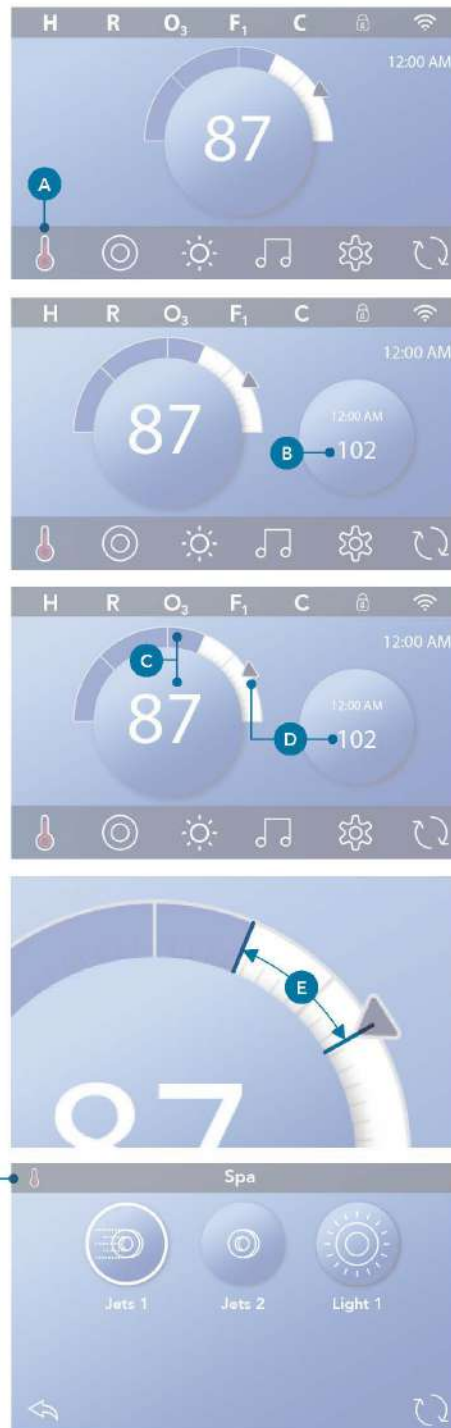

Note: the Heater Status button icon flashes during heater start-up; this is normal.



RUN SPA DEVICES

Press the Spa button  (A) to view the Spa screen. Press these buttons (B) to run spa devices. Some devices may only turn On and Off, while other devices may have multiple speeds/states. Your spa configuration determines the number of buttons and the function of the buttons in the Spa screen. One Spa screen displays six buttons, maximum. If more than six buttons exist, a navigation button appears (D). Press the navigation button (D), or swipe, to view the next Spa screen. Press the Back button  (C) to navigate to the Main screen.

If the Jets are left running, they will turn off after a time-out period.

If the Spa has a circulation pump, a circulation pump icon will appear in the Spa screen to indicate its activity only (the icon is not a functioning button). The circulation pump can be controlled with a button during Priming mode (view page 26).

If the spa does not have a circulation pump, then Jets 1 may turn On automatically at times. In these cases, pressing the Jets 1 button will just change speeds, but will not turn Off Jets 1.

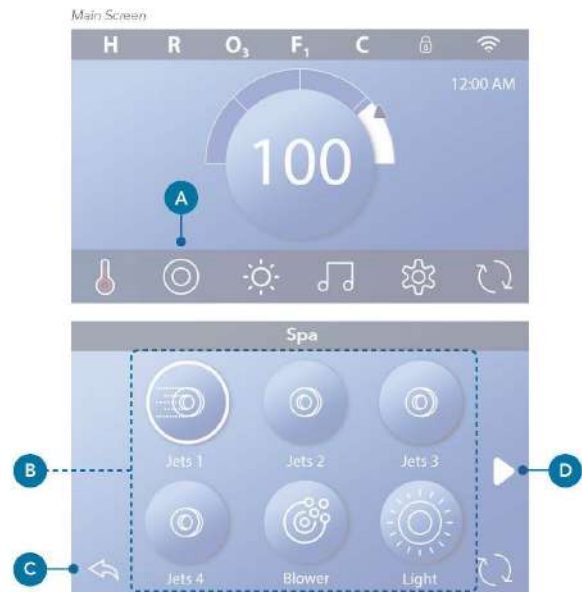

Spa Button



SET FILTER CYCLE TIME

Keep your water clean and ready to enjoy

Follow these steps to set the time for Filter Cycle 1.

- Press the Settings button (A) on the Main screen.
- Press the Filter button (B) on the Settings screen.
- Press the Start button (E) on the Filter Cycles screen.
- Set the Start Time with these dials (J) on the F1 End screen.
- Press the Save button (K) to save your settings, or press the Cancel button (I) to cancel your settings.
- Press the End button (F) on the Filter Cycles screen, and follow the same steps to set the End Time.
- Once the Start and End Times are set, press the Save button (G) on the Filter Cycles screen.
- Once Start and End Times are set, the Duration appears here (H). You have now set the time for Filter Cycle 1. The white ring (C) indicates that Filter Cycle 1 is enabled (it is always enabled).

Follow the same steps noted above to set the time for Filter Cycle 2.

How can you tell if Filter Cycle 2 is enabled?

Filter Cycle 2 is enabled when a white ring appears around the ② button. For example, Filter Cycle 1 is enabled (C) in this screen, and Filter Cycle 2 is disabled (D). Press the ② button to enable/disable Filter Cycle 2. A Filter Cycle 2 will only run if it is enabled.

Note: It is possible to overlap Filter Cycle 1 and Filter Cycle 2, which will shorten overall filtration by the overlap amount.



Adjusting Filtration

Circulation Pump Modes

Some spas may be manufactured with Circ Pump settings that allow programming filtration cycle duration. Some Circ Modes are pre-programmed to operate 24 hours a day and are not programmable. Refer to the spa manufacturer's documentation for any Circulation Pump Mode details.

Purge Cycles

In order to maintain sanitary conditions, as well as protect against freezing, secondary water devices will purge water from their respective plumbing by running briefly at the beginning of each filter cycle. (Some systems will run a certain number of purge cycles per day, independent of the number of filter cycles per day. In this case, the purge cycles may not coincide with the start of the filter cycle). If the Filter Cycle 1 duration is set for 24 hours, enabling Filter Cycle 2 will initiate a purge when Filter Cycle 2 is programmed to begin.

The Meaning of Filter Cycles

1. The heating pump always runs during the filter cycle*
2. In Rest Mode, heating only occurs during the filter cycle
3. Purges happen at the start of each filter cycle (on most systems).

* For example, if your spa is set up for 24/hour circulation except for shutting off when the water temperature is 3°F/1.3°C above the set temperature, that shutoff does not occur during filter cycles.

Additional Settings

Auxiliary Panel(s)

Specific Buttons for Specific Devices



If the spa has an Auxiliary Panel(s) installed, pressing buttons on that panel will activate the device indicated for that button. These dedicated buttons will operate just like the Spa Screen buttons (see page 12) and the equipment will behave in the same manner with each button press.



RESTRICT OPERATIONS

The following examples show how to lock and unlock the Panel.

LOCK PANEL

- Press the Settings button  (A) on the Main screen.
- Press the Locks button  (B) on the Settings screen.
- Press the Panel button (C) on the Locks screen. "Lock Panel" will appear at the top of the screen (D).
- Press-&-hold "Lock Panel" (D) for five seconds. After five seconds a Lock icon  (E) will appear in the top row. The lock icon also appears in the top row of the Main screen. The panel is now locked.

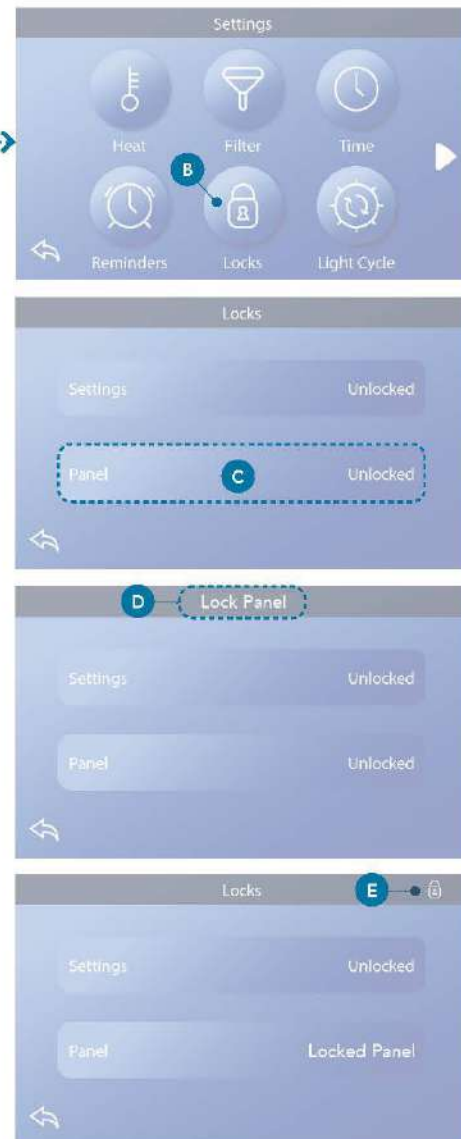

(Continued on next page)

UNLOCK PANEL

- Press the Panel button (F) in the Locks screen, and “Unlock Panel” will appear at the top of the screen (G).
- Press-&-hold “Unlock Panel” (G) for five seconds. After five seconds the Lock icon  will disappear from the top row (I) of the Locks screen. The panel is now Unlocked.

The control can be restricted to prevent unwanted use or temperature adjustments. Locking the Panel prevents the controller from being used, but all automatic functions are still active.

LOCK & UNLOCK SETTINGS

Follow the same steps noted above to lock and unlock Settings.

Locking the Settings allows Jets and other features to be used, but the Set Temperature and other programmed settings cannot be adjusted. Settings Lock allows access to a reduced selection of menu items. These include Filter Cycles (view only), Invert, Information and Fault Log. They can be seen, but not changed or edited.

Can Settings and Panel be locked simultaneously?

Yes. The lock icon  (K) appears if Settings or Panel or both are locked. The current lock states are noted on the right side of the buttons (H).

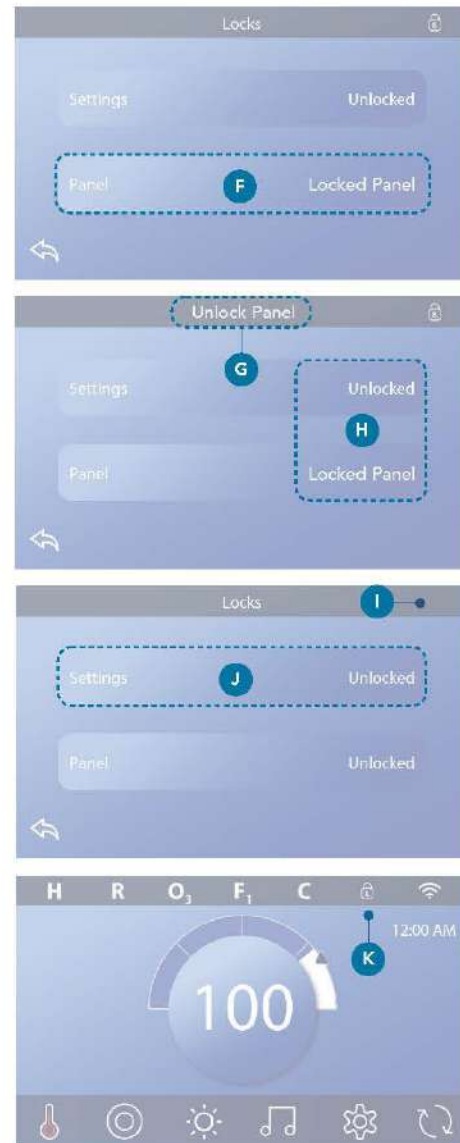

SPA BEHAVIOR



Pumps

Pumps drive water and air through the jets. A pump typically has one or two speeds. If left running, a pump will turn off after a time-out period.

Circulation Pump

A circulation pump is usually smaller, quieter, and requires less energy than a pump used for jets. A circulation pump typically has one speed and circulates water through the spa's filtration system to keep the water clean. The circulation pump also runs when the blower or any other pump is on.

Non-Circulation Pump Systems (or "non-circ systems")

If a spa does not have a circulation pump, another pump will function in its place. The low-speed of pump 1 runs when the blower or any other pump is on. If the spa is in Ready Mode (See page 22), Pump 1 low may also activate for at least 1 minute at various intervals to detect the spa temperature (polling) and then to heat to the set temperature if needed. When the low-speed turns on automatically, it cannot be deactivated from the panel, however the high speed may be started.

Circulation Pump Modes

If the system is equipped with a circulation pump, it will be configured to work in one of three different ways:

1. The circulation pump operates continuously (24 hours) with the exception of turning off for 30 minutes at a time when the water temperature reaches 3°F (1.5°C) above the set temperature (most likely to happen in very hot climates).
2. The circulation pump stays on continuously, regardless of water temperature.
3. A programmable circulation pump will come on when the system is checking temperature (polling), during filter cycles, during freeze conditions, or when another pump is on.

The specific Circulation Mode that is used has been determined by the Manufacturer and cannot be changed in the field.

Filtration and Ozone

If a spa does not have a circulation pump, Pump 1 low and the ozone generator will run during filtration. On circ systems, the ozone will generally run with the circulation pump, but can be limited to filtration cycles. (On some circ systems, Pump 1 low will run along with the circulation pump during filtration.)

Most systems are factory-programmed with one filter cycle that will run in the evening (assuming the time-of-day is properly set) when energy rates are often lower. The filter time and duration are programmable. A second filter cycle can be enabled as needed. At the start of each filter cycle, the water devices like blower, mister device (if these exist) and other pumps will run briefly to purge the plumbing to maintain good water quality.

Freeze Protection

If the temperature sensors within the heater detect a low enough temperature, then the water devices automatically activate to provide freeze protection. The water devices will run either continuously or periodically depending on conditions. In colder climates, an optional freeze sensor may be added to protect against freeze conditions that may not be sensed by the standard sensors. Auxiliary freeze sensor protection acts similarly except with the temperature thresholds determined by the switch. See your dealer for details.



Clean-up Cycle (optional)

When a pump or blower is turned on by a button press, a clean-up cycle begins 30 minutes after the pump or blower is turned off or times out. The pump and the ozone generator will run for 30 minutes or more, depending on the system. On some systems, you can change this setting.

Clean-up cycles allow the spa to filter less when the spa is used less often, and to filter more when the spa is used more often.

DIAGNOSTICS SCREEN

The Diagnostics screen is helpful for spa technicians.

Here is how to navigate to the Diagnostics screen starting from the Main screen. Pressing the Settings button  and then the Diagnostics button .

Info

Info (A) displays various settings and identifications of this system.

System Model

Displays the Model Number of the System.

Panel Version

Displays a number of the software in the topside control panel (D).

Software ID (SSID)

Displays the software ID number for the System.

Configuration Signature

Displays the checksum for the system configuration file.

Current Setup

Displays the currently selected Configuration Setup Number.

Dip Switch Settings

Displays a number that represents the DIP switch positions of S1 on the main circuit board.

Heater Type

Displays a heater type ID number, or "Standard".

Heater Voltage (North American system / UL)

North American/UL control systems display operating voltage configured for the heater.

Heater Wattage (International System / CE)

International/CE control systems display the heater wattage range that is configured for the control system.

Faults

Faults (B) is a record of the last 24 faults that can be reviewed by a service tech. Use the arrow buttons to view each entry in the Fault Log. When Priming Mode shows in the Fault Log, it is not a fault. Rather, it is used to keep track of spa restarts.



GFCI Test

(North America Only. Feature not available on CE rated systems.)

Your systems may have GFCI configured in one of three ways:

1. GFCI test is not enabled
2. Manual GFCI test is enabled but automatic GFCI test is not enabled
3. Both manual and automatic GFCI tests are enabled.

The automatic test will happen within 7 days of the spa being installed and if successful will not repeat. (If the automatic test fails it will repeat after the spa is restarted.)

The GFCI Test button (C) will appear on the Diagnostics screen only if the GFCI is enabled.

The GFCI Test screen (view next page) allows the GFCI to be tested manually from the panel and can be used to reset the automatic test feature.

The Ground Fault Circuit Interrupter (GFCI) or Residual Current Detector (RCD) is an important safety device and is required equipment on a hot tub installation. (The GFCI Test Feature is not available on CE rated systems).

Used for verifying a proper installation

Your spa may be equipped with a GFCI Test feature. If your spa has this feature enabled by the manufacturer, the GFCI Trip Test must occur to allow proper spa function. On some systems:

Within 1 to 7 days after startup, the spa will trip the GFCI to test it. (The number of days is factory programmed.) The GFCI must be reset once it has tripped. After passing the GFCI Trip Test, any subsequent GFCI trips will indicate a ground fault or other unsafe condition and the power to the spa must



be shut off until a service person can correct the problem.

On systems that do not have the automatic GFCI test, the manual GFCI test must be done.

Forcing a manual GFCI Trip Test

The installer can cause the GFCI Trip Test to occur at any time by pressing Test on the GFCI Test screen. The GFCI should trip within several seconds and the spa should shut down. If it does not, shut down the power and manually verify that a GFCI breaker is installed and that the circuit and spa are wired correctly. Verify the function of the GFCI with its own test button. Restore power to the spa and repeat the GFCI Trip Test. Once the GFCI is tripped by the test, reset the GFCI and the spa will operate normally from that point. You can verify a successful test by navigating to the above screen. "Passed" should appear on the GFCI screen.

Warning:



On those systems that automatically test the GFCI within 1 to 7 days after startup:

The end-user must be trained to expect this one-time test to occur. The end-user must be trained how to properly reset the GFCI. If freezing conditions exist, the GFCI or RCD should be reset immediately or spa damage could result.

GFCI Test (Continued)

Perform a GFCI Test

Start at the Main screen and follow these steps to manually test the GFCI.

- Press the Settings button  on the Main screen.
- Press the Diagnostics button  on the Settings screen.
- Press the GFCI Test button (C) on the Diagnostics screen. The GFCI Test screen will appear.

If the GFCI Test status is "Passed" (F), you may not need to perform this test.

If the GFCI Test status is "Armed" (D), proceed to the next step.

- Press the Test button (E).

Within approximately 12 seconds, one of the following two things will happen:

1 - The spa powers down. After the spa powers down, go to the GFCI and power up the spa. The spa goes into Priming Mode when it is powered up. When Priming Mode is complete, navigate to the GFCI Test screen and confirm that it says "GFCI Status - Passed" (F).

2 - A "GFCI Test Failed" message appears. In this case, contact a qualified service technician. While you wait for the spa technician to arrive, the spa can be run normally for a time by cycling the power.

Reset Button:

Only use the Reset Button prior to moving the spa to a new location. Pressing the Reset the button forces a new Test to be performed at the new location.





CE Product

CE registered systems do not have an RCD Test Feature due to the nature of the electrical service. The end-user must be trained how to properly test and reset the RCD.

HEAT SETTINGS

Ready to enjoy!

Make sure your spa is heated and ready to enjoy with Heat Settings. Navigate to the Heat Settings screen from the Main screen by pressing the Settings button . Press the Heat button , and the Heat Settings screen appears (A). The Heat Setting screen does not have Save or Cancel buttons, so changes you make take effect immediately.

Heat Mode (B)

Ready **R**

Ready Mode (B) keeps the water temperature within 1° F (0.5° C) of the Set temperature. For example, if the set temperature is 102° F (39.0° C), the water temperature will be within +/- 1° F (0.5° C) of 102° (39.0° C). Press the Heat Mode button (B) to switch between Read and Rest Mode. The **R** icon appears on the Main screen when the spa is in Ready Mode.

Rest **R**

Rest Mode functions the same as Ready Mode, except Rest Mode only heats the water during filter cycles (view page 13). Press the Heat Mode button (B) to switch between Read and Rest Mode. The **R** icon appears on the Main screen when the spa is in Rest Mode.

Ready-in-Rest **RR**

Ready-in-Rest Mode is the same as Rest Mode, except Ready-in-Rest Mode heats the water, if necessary, for one hour when you turn On Jets 1. The **RR** icon

appears on the Main screen when the spa is in Rest-in-Rest Mode.

If the spa is in Ready-in-Rest mode and you go to the Heat Settings screen (A), that cancels Ready-in-Rest Mode and puts you back into Rest Mode, even if you press no buttons while on the Heat Settings screen.

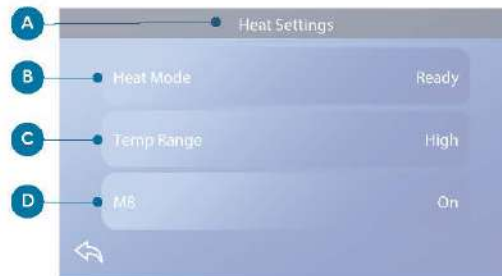

Heater Pump

In order for the spa to heat, a pump needs to circulate water through the heater. The pump that performs this function is known as the "heater pump".

The heater pump can be either a 2-speed pump (Pump 1) or a circulation pump. If the heater pump is a 2-Speed Pump 1, Ready Mode will circulate water at various intervals, using Pump 1 Low, in order to maintain a constant water temperature, heat as needed, and refresh the temperature display. This is known as "polling."

Rest Mode will only allow heating during programmed filter cycles. Since polling does not occur, the temperature display may not show a current temperature until the heater pump has been running for a minute or two. When the heater pump has come on automatically (for example for heating) you can switch between low speed and high speed but you cannot turn the heater pump off.

Temp Range (C)

There are two Temp Range settings: High and Low.

High **H**

The water temperature can be set between 80° - 104° F (26.6° - 40.0 C) when Temp Range is set to High. Press the Temp Range button (C) to switch between High and Low Range. The **H** icon appears in the top row of the Main screen when the spa is in High Range.

Low **L**

The water temperature can be set between 50° - 99° F (10.0° - 37.2° C) when Temp Range is set to Low. Press the Temp Range button (C) to switch between High and Low Range. The **L** icon appears in the top row of the Main screen when the spa is in Low Range.

Different High and Low Temp Ranges may be determined by the Manufacturer.

Freeze Protection is active in High and Low range.



M8

Press the M8 button (D) to turn it On/Off. The M8 feature looks for opportunities to decrease pump usage, which may increase pump life and save energy. M8 is On by default. M8 is an optional feature and may not appear on all systems.



SETTINGS SCREEN

Fine tune your spa with a wide variety of Settings.

Starting from the Main screen, press the Settings button  to view the Settings screen (A). Press the navigation arrows   or swipe to view all of the Settings screens.

Heat

Make sure your spa is heated and ready to enjoy with Heat Settings. (view page 22).

Filter

Keep your spa water clean and ready to enjoy by setting Filter Cycles (view page 13).

Time

Set the Time to insure scheduled features have proper timing (view page 9).

Reminders

Reminders (A) are helpful spa maintenance messages that display periodically.

Locks

Lock the Panel and/or Setting (view page 15).

Light Cycle (Optional)

If you want the spa lights to turn On and Off at a specific times, use Light Cycle (A).

Hold

Hold (B) is used to disable the pumps during service functions like cleaning or replacing the filter. Hold Mode will last for 1 hour unless the mode is exited manually. If spa service will require more than an hour, it may be best to simply shut down power to the spa. The Hold Icon on the Settings Screen places the spa in Hold Mode and displays the System Hold screen. Touch Back to exit Hold Mode.



Hold (continued)

Drain Mode (Optional)

Some spas have a special feature that allows Pump 1 to be employed when draining the water. When available, this feature is a component of Hold.

Cleanup

When a pump or blower is turned on by a button press, a clean-up cycle begins 30 minutes after the pump or blower is turned off or times out. The pump and the ozone generator will run for 30 minutes or more, depending on the system. On some systems, you can change this setting.

Units

Specify Time and Temperature Units (B). The temperature choices are Fahrenheit or Celsius. The time display choices are 12 hour or 24 hour.

Language

Select from a variety of languages.

Panel

Set how long it takes the panel to go to sleep after the last activity. The default is 1 minute. The shortest time (1 minute) is recommended because it decreases the chance of water activating buttons.

CHROMAZONE™ (Optional)

If your spa is equipped with CHROMAZONE™, refer to the CHROMAZONE™ user guide that came with the spa. If a user guide was not included, please contact the spa dealer or manufacturer.

Diagnostics

Spa technicians can find useful information and features in Diagnostics (C) (view page 19).



FILL IT UP!

Follow these steps to prepare you spa.

Preparation & Filling

Fill the spa to its correct operating level. Be sure to open all valves and jets in the plumbing system before filling to allow as much air as possible to escape from the plumbing and the control system during the filling process. After turning the power on at the main power panel, the top-side panel will display a splash screen or startup screen.

Priming Mode – M019*

After the initial start-up sequence, the control will enter Priming Mode and display a Priming Mode screen. Only pump icons appear on the priming mode screen. During the priming mode, the heater is disabled to allow the priming process to be completed without the possibility of energizing the heater under low-flow or no-flow conditions. Nothing comes on automatically, but the pump(s) can be energized by selecting the "Jet" buttons. If the spa has a Circ Pump, it can be turned on and off by pressing the "Circ" button during Priming Mode.

Priming the Pumps

As soon as the Priming Mode screen appears on the panel, select the "Jets 1" button once to start Pump 1 in low-speed and then again to switch to high-speed. Also, select the other pumps, to turn them on. The pumps should be running in high-speed to facilitate

priming. If the pumps have not primed after 2 minutes, and water is not flowing from the jets in the spa, do not allow the pumps to continue to run. Turn off the pumps and repeat the process. Note: Turning the power off and back on again will initiate a new pump priming session. Sometimes momentarily turning the pump off and on will help it to prime. Do not do this more than 5 times. If the pump(s) will not prime, shut off the power to the spa and call for service. Important: A pump should not be allowed to run without priming for more than 2 minutes. Under NO circumstances should a pump be allowed to run without priming beyond the end of the 4 minute priming mode. Doing so may cause damage to the pump and cause the system to energize the heater and go into an overheat condition.

Exiting Priming Mode

The system will automatically enter the normal heating and filtering at the end of the priming mode, which lasts 4 minutes. You can manually exit Priming Mode by pressing the "Back" button on the Priming Mode Screen. Note that if you do not manually exit the priming mode as described above, the priming mode will be automatically terminated after 4 minutes. Be sure that the pump(s) have been primed by this time. Once the system has exited Priming Mode, the top-side panel will display the Main Screen, but the display will not show the water temperature yet. This is because the system requires approximately 1 minute of water flowing through the heater to determine the water temperature and display it.

*M0XX is a Message Code.

MESSAGES

General Messages

Several alerts and messages may be displayed in a sequence.

Possible freezing condition

A potential freeze condition has been detected, or the Aux Freeze Switch has closed. All water devices are activated. In some cases, pumps may turn on and off and the heater may operate during Freeze Protection. This is an operational message, not an error indication.

The water is too hot – M029*

The system has detected a spa water temp of 110°F (about 43°C) or more, and spa functions are disabled. System will auto reset when the spa water temp is below 108°F (about 42°C). Check for extended pump operation or high ambient temp.

The water level is too low

This message can only appear on a system that uses a water level sensor. It appears whenever the water level get too low (or the water level sensor is disconnected), and automatically disappears when the water level is adequate. Pumps and the heater turn OFF when this message appears.

Heater-Related Messages

The water flow is low – M016**

There may not be enough water flow through the heater to carry the heat away from the heating element. Heater start up will begin again after about 1 minute. See “Flow Related Checks” below.

The water flow has failed* – M017**

There is not enough water flow through the heater to carry the heat away from the heating element and the heater has been disabled. See “Flow Related Checks” below. After the problem has been resolved, reset the message*.

The heater may be dry* – M028**

Possible dry heater, or not enough water in the heater to start it. The spa is shut down for 15 minute. Reset this message* to reset the heater start-up. See “Flow Related Checks” below.

The heater is dry* – M027**

There is not enough water in the heater to start it. The spa is shut down. After the problem has been resolved, you must reset the message* to restart heater start up. See “Flow Related Checks” below.

The heater is too hot* – M030**

One of the water temp sensors has detected 118°F (about 48°C) in the heater and the spa is shut down. You must reset the message* when water is below 108°F (about 42°C). See “Flow Related Checks” below.

Flow-related checks

Check for low water level, suction flow restrictions, closed valves, trapped air, too many closed jets and pump prime. On some systems, even when spa is shut down by an error condition, some equipment may occasionally turn on to continue monitoring temperature or if freeze protection is needed.

Sensor-Related Messages

Sensors are out of sync – M015**

The temperature sensors may be out of sync by 3°F. Call for Service if this message does not disappear within a few minutes.

Sensors are out of sync – Call for service* – M026**

The temperature sensors ARE out of sync. The fault above has been established for at least 1 hour. Call for Service.

Sensor A Fault, Sensor B Fault – Sensor A: M031**, Sensor B: M032**

A temperature sensor or sensor circuit has failed. Call for Service.

System-Related Messages

Program memory failure* – M022**

At Power-Up, the system has failed the Program Checksum Test. This indicates a problem with the firmware (operation program) and requires a service call.

The settings have been reset (Persistent Memory Error)* – M021**

Contact your dealer or service organization if this message appears on more than one power-up.

The clock has failed* – M020**

Contact your dealer or service organization.

Configuration error

The spa will not Start Up. Contact your dealer or service organization.

The GFCI test failed (System Could Not Test the GFCI) – M036**

(North America Only) May indicate an unsafe installation. Contact your dealer or service organization.

A pump may be stuck on – M034**

Water may be overheated. POWER DOWN THE SPA. DO NOT ENTER THE WATER. Contact your dealer or service organization.

Hot fault – M035**

A Pump Appears to have been Stuck ON when spa was last powered. POWER DOWN THE SPA. DO NOT ENTER THE WATER. Contact your dealer or service organization.

Reminder Messages

Reminder messages can be reset from the panel. Press the Clear Icon to reset the Reminder message.

General maintenance helps

Reminder Messages can be suppressed by using the Reminders Screen. Reminder Messages can be chosen individually by the Manufacturer. They may be disabled entirely, or there may be a limited number of reminders on a specific model. The frequency of each reminder (i.e. 7 days) can be specified by the Manufacturer.

Check the pH

May appear on a regular schedule, i.e. every 7 days. Check pH with a test kit and adjust pH with the appropriate chemicals.

Check the sanitizer

May appear on a regular schedule, i.e. every 7 days. Check sanitizer level and other water chemistry with a test kit and adjust with the appropriate chemicals.

Check ozone

May appear on a regular schedule. Change the UV as instructed by the manufacturer.

Reminder Messages

(Continued)

Service check-up

May appear on a regular schedule. Do a service check-up as instructed by the manufacturer.

Additional messages may appear on specific systems.

Clean the filter

May appear on a regular schedule, i.e. every 30 days. Clean the filter media as instructed by the manufacturer.

Test the GFCI (or RCD)

May appear on a regular schedule, i.e. every 30 days. The GFCI or RCD is an important safety device and must be tested on a regular basis to verify its reliability. Every user should be trained to safely test the GFCI or RCD associated with the hot tub installation. A GFCI or RCD will have a TEST and RESET button on it that allows a user to verify proper function.

Change the water

May appear on a regular schedule, i.e. every 90 days. Change the water in the spa on regular basis to maintain proper chemical balance and sanitary conditions.

Clean the cover

May appear on a regular schedule, i.e. every 180 days. Vinyl covers should be cleaned and conditioned for maximum life.

Treat the wood

May appear on a regular schedule, i.e. every 180 days. Wood skirting and furniture should be cleaned and conditioned per the manufacturers instructions for maximum life.

Change the filter

May appear on a regular schedule, i.e. every 365 days.

Filters should be replaced occasionally to maintain proper spa function and sanitary conditions.

Change the UV

May appear on a regular schedule. Change the UV as instructed by the manufacturer.

Miscellaneous Messages

Set the Time-of-Day

When a control system that displays this message is powered On, its time-of-day is initialized to 12:00 PM. Setting the proper time-of-day is important for determining filtration times and other background features (view page 9).

Communications error

The control panel is not receiving communication from the System. This can appear briefly during system start-ups. This is normal. If it does not go away quickly, Call for Service.

Test software installed

The Control System is operating with test software. Call for Service.

Message Notes

Some messages include the "Call for Service" text as it requires a service technician to fix the problem.

If the panel is locked and a message alert appears, you will be taken to the Lock Screen (where you will need to Unlock the panel) before you can clear the message.

Touching the Error/Warning/Reminder/Info Icon on the Message Screen will take you to the System Information Screen to allow for troubleshooting over the phone or for a field service tech to better understand what is going on. Exiting the System Information Screen will take you back to the Message Screen in that situation.

BLUETOOTH AUDIO SYSTEM

- 2 EXTERIOR CABINET SPEAKERS

If applying power, listen for the tonal beeps indicating that the Bluetooth system is looking to pair with a BT device.

- Go to the Bluetooth setting on your device (Smartphone, Tablet, etc.)
- Look for the device “V4BT4015”
- Connect. No passcode is necessary. Unless you have been given a passcode to enter
- Go to your music app. Select an audio track and play

Your device may ask you if you want to connect to the V4BT4015 or to your device’s speakers.

DELUXE AQUACOUSTIC BLUETOOTH AUDIO SYSTEM WITH SUBWOOFER

- 4/6 INTERIOR SPEAKERS

If applying power, listen for the tonal beeps indicating that the Bluetooth system is looking to pair with a BT device.

- Go to the Bluetooth setting on your device (Smartphone, Tablet, etc.)
- Look for the device “Aquatic AW SWA6” and pair with passcode “0000”. Connect
- Go to your music app. Select an audio track and play

Your device may ask you if you want to connect to the Aquatic AV SWA6 or to your device’s speakers.

IMPORTANT



Some audio devices have music settings where you can customize the audio output Based on the type of music you are listening to (more or less base, small speakers vs. large speakers, country music vs. pop or rock) and these are just a few of the various settings that can help you achieve the ultimate listening experience.

If the system does not sense an audio signal for longer than 1 minute, it will shut off automatically to reduce potential background noise. You may need to re-connect to your BT device again to listen to music.

THRU WALL SKIMMER

The spa's thru wall skimmer provides water to the primary pump on low speed as well as skimming action to trap debris in the removable basket.



To access the removable basket:

1. Turn the spa off at the GFCI/breaker
2. Remove the guillotine-style skimmer by gently pulling the assembly up to release the latching tabs. This skimmer can now be removed by lifting it up and out from the acrylic wall.
3. Locate the lift tab on the back edge of the basket and slide the basket up and out. The basket will release from its' front locking clip, so you can maneuver the basket out of the base of the skimmer and dump it.
4. Re-install the basket making sure that the front tab latches into the skimmer body.
5. Re-install the skimmer to the acrylic wall by relocating the latching tabs in the cut-outs of the trim plate. Then slide the skimmer down until you hear the latching of the tabs lock into place.
6. Turn the spa back on at the GFCI/breaker. We also recommend that you bleed any entrapped air off at the filter top air bleeder. See cartridge access/changing instructions.



ACCESSING FILTER CARTRIDGES

TOP LOAD PRESSURE FILTER



1. Shut off your spa at the Ground Fault Circuit Interrupter (GFCI) or Residual Current Detector (RCD). Alternatively, you can place your spa in HOLD (Standby) mode. This will provide you with up to 60 minutes to do service including changing/replacing your filter cartridge.

For spas with the TP600 keypad refer to page 30.

For spas with the SpaTouch2T keypad refer to page

64.

2. Remove the filter cover/drink tray.
3. Lift the lock tab to release the filter ring from the filter body. Turn ring to remove it. Set aside.
4. Open the air bleed screw on the filter lid.
5. Pull up on the filter lid to remove. It is sealed with an “o” ring on the outer edge. This can take some force.
6. Remove the cartridge by lifting straight up.
7. Examine, clean, rotate or replace the cartridge as necessary.
8. Reverse the procedure to install new or clean cartridge.
9. Close the air bleed screw.
10. Ensure top ring’s locking tab is locked into the filter body before restarting the spa.
11. Open air bleed screw slightly to bleed off any entrapped air in the top of the filter body.

Note: As you open the filter to inspect, clean or replace the cartridge, water will accumulate in the molded filter niche. The niche has been designed with a drain fitting in a recessed keyhole space. This drain has a rubber plug on a tethered strap. To send accumulated water back into the spa simply remove the plug and turn pump 1 onto high speed for a few seconds. When the water is drained away, turn the pump back to low speed and replace the plug

MAINTENANCE

To protect the equipment and the bathers using your spa, regular maintenance must be performed.

CARING FOR THE ACRYLIC SURFACE

This beautiful acrylic surface is among the glossiest, high quality surface materials available. It's hard, non-porous surface prevents dirt from accumulating and resists stains better than other plastic materials. With normal use, it is so durable it will retain its beauty with only a minimum of care. So, to maintain the high gloss and elegant look, just follow these simple steps:

- Use common household, non-abrasive cleaners for most cleaning jobs. (For example: LYSOL BASIN, TUB & TILE CLEANER, GLASS PLUS, MR. CLEAN and TOP JOB, or a mild dishwashing detergent such as IVORY LIQUID) Rinse well and dry with a clean cloth.
- Never use abrasive cleaners.
- Do not allow your acrylic surface to come into contact with products such as acetone (nail polish remover), nail polish, dry cleaning solution, lacquer thinners, gasoline, pine oil, etc.
- Remove dust and dry dirt with a soft, damp cloth.
- Clean grease, oil, paint, and ink stains with isopropyl (rubbing) alcohol.
- Avoid using razor blades or other sharp instruments that might scratch the surface. Small scratches can be removed by applying a thin coat of automotive paste wax and buffing lightly with a clean cloth. For deeper scratches, sand the surface lightly with 600 grit "wet" sandpaper (never dry) and buff with fine-grit buffing compound.

If you don't rinse off any surface cleaner thoroughly, you will experience excessive foaming on refilling and start-up. Periodic application of a good wax adds lustre to the appearance and protects the finish.

CLEANING THE SPA'S CABINET

Cleaning the cabinet is easy and fast with many common household cleaners. The cleaning solution should be applied and immediately wiped dry. The cleaning solution should not be left to stand on the material for an extended period of time.

Recommended Cleaners:

Windex, Glass Plus, 409 Glass & Surface Cleaner, Spic and Span Cinch, Fantastik All-Purpose, Regency (Glass & Surface), Clorox Clean-Up and Fantastik Orange Action

Cleaners to Avoid:

Harsh cleaners with glycol ethers or ethanol type solvents and/or isopropyl alcohol soften the coating if left on for several minutes.

Cleaners such as Goof Off, Great Value All Purpose Cleaner (Wal-Mart), 409 General Purpose, Greased Lightning, citrus cleaners, abrasive cleaners, and solvents such as acetone, paint remover and lacquer thinner are **NOT** recommended for cleaning the cabinet.

CLEANING THE WATER LAMINARS

The Water Laminars, often called water ropes, have a unique stream shape much like your kitchen faucet. This is done by an internal screen that helps straighten the flow and create the laminar effect. Any debris in the tubing leading up to the laminars will be trapped by the screen. This could result in uneven water arches. Often debris from trees close to the spa can be the cause of the debris.

The screen may be cleaned by removing the laminar face and pulling/washing off any debris in a sink before re-installing the face. Simply turn the face gently to unlatch it from the body. To re-install, insert the face and turn until you feel it latch.

REINSTALLING A POLYSTEEL CABINET PANEL

If you look along the bottom section of the metal frame you should find two small pilot holes, each probably about a third of the way in from each corner. If you place a screw in each hole (just a couple turns), you can then rest the panel on top of these screws to balance it.

SPA HARD COVER

In an uncovered spa, over 90% of the heat loss is from the spa surface. The evaporation also affects the chemical balance and could create humidity problems indoors.

Hard covers are engineered for maximum thermal efficiency and appearance. They are hinged in the middle for easier handling, and the zippers allow the tapered Styrofoam inserts to be changed if damaged.

The skirt on the cover hugs the lip of the spa for a tight fit. The handles are placed so even a large cover can be easily opened by 1 person.

The locks, with one part fastened to the deck or skirt, prevent small children or animals from entering the spa.

- Do not drag the cover across the spa or decking. Fold cover first, and then remove with assistance.
- Do not place the spa where snow loads are excessive on the cover. If snow accumulates on the cover, carefully remove the snow.
- Do not shovel the snow as the cover will tear.
- Do not stand on the hard cover. The cover is not warranted against the foam breaking or the vinyl cover tearing.
- Do not use abrasive cleaners or leather restoration-type cleaners. Use only water and a mild detergent.

JET MAINTENANCE

Several of the jets in your spa are volume adjustable. The volume adjustment of the jet internals in these jets can be affected by debris in the spa water. If you feel the volume adjustment getting stiff, you should consider removing and washing the internal at the next scheduled fill and drain of the spa.

To Remove an Adjustable Jet Internal

- 1) Turn the jet face to the maximum volume position (fully counter clockwise).
- 2) The jet face will feel as if it has stopped but if you continue to turn the face, the jet internal will thread out of the body.
- 3) Check the inside of the jet body and the internal for any debris and calcium build up.
- 4) Wipe out the inside of the jet body, if necessary.
- 5) Wash the internal in your service sink. Scrub, gently, if necessary.
- 6) To re-install a jet internal simply thread the internal in until it stops. Now continue turning until the internal locks into its volume adjustment range.

If you find high levels of calcium build up or any discolouration of the jet internal when removed, you should take a spa water sample to your dealer for testing.

FILTER SYSTEM

GENERAL INFORMATION

You will need to regularly inspect your filter cartridges to ensure they are clean.

As your cartridges get dirtier, they could effect:

- **Heating of the spa water:** restricted water flow from a clogged filter can cause error codes to display on the control pad and prevent the spa from heating properly
- **Water quality:** a change in function of the ozone injection system can result in a drop, or complete stop, of ozone draw into the spa water

Keeping a second set of cartridges and rotating out dirty ones for clean ones can help keep your water clean*, reduce chemical consumption and down time due to cartridge cleaning.

SPECIAL NOTE: Several replacement cartridges look similar. Using the wrong cartridge may cause problems. Ask your dealer for the code that identifies your cartridge and record it.

* Clean is defined as the removal of microscopic (to 30 µm level) debris from the water. Ozone aids in the grouping of small debris. Once combined, the debris can be more easily caught by the filtration process.

CLEANING FILTER CARTRIDGES

- 1) Remove large debris by separating cartridge folds and spraying with a stream of water. Your kitchen or laundry sink is useful for this.
- 2) Contaminants that cause the cartridge to become brownish or greyish in colour require soaking overnight in specially formulated cartridge cleaner (available from your dealer).
- 3) Use a large plastic pail and follow the package directions. For safety reasons, you should locate your soaking pail out of reach of children.
- 4) Rinse the cartridge thoroughly to remove all the cleaner.
- 5) Allow cleaned cartridge to dry completely before re-using.
- 6) Spread pleats and run a soft brush through each one individually to complete the cleaning process.



DRAINING YOUR SPA

KNOWING WHEN TO DRAIN

Dissolved solids from bather load and ongoing chemical treatment accumulate in your spa water. The early sign of a high level of dissolved solids is unmanageable cloudy water.

When in doubt, remember that the best chemical for your spa is fresh water!

HOW TO DRAIN YOUR SPA

- 1) Turn down the set point on your spa and allow adequate time for the water to cool down. Uncover and run high speed pump to speed up cooling.
- 2) Turn power off to your spa.
- 3) Attach the appropriate size hose to the drain connection (see below).
- 4) Route the hose to an appropriate drain location.
- 5) When the drain is opened the spa will gravity drain, even unattended.
- 6) As draining proceeds, move water from contours of seats, into the footwell. Draining will stop due to drain height.
- 7) Remove any remaining water with a shop vac, sponge and pail or simply dilute in your fresh fill.
- 8) Before refilling, clean spa surface as necessary.
- 9) Don't forget to close the drain before refilling.

If you want to speed up the draining process, simply use a submersible sump pump available through most hardware stores.

Drain Connections

MAGIC Drain (Outer Cabinet)

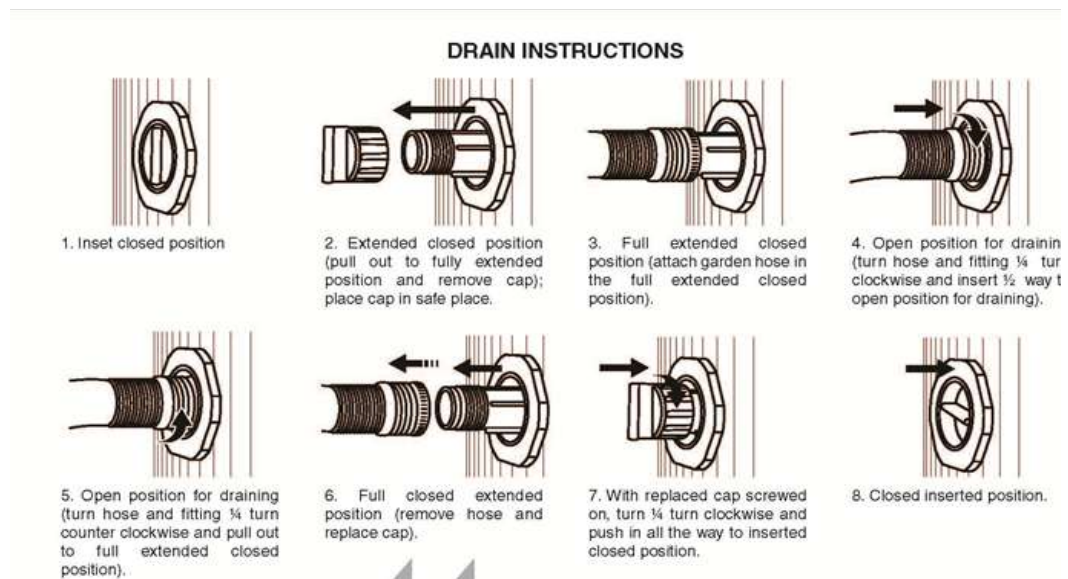

When Vacuuming Spa Lines:

- 1) Vacuum at all suction in the foot well. This could be 2-6 suction depending on the model.
- 2) Vacuum at the heater input (union and gate valve), usually on the left of the equipment side of the spa. Make sure to vacuum until you feel no more water coming out, then block the 2 cartridge mounts or block the Elite or Teleweir opening.

Remove the cartridge(s). Thread plugs into the threaded cartridge mounts in the filter box. For Elite or Teleweir filter system, remove the trim ring and weir. Cover the filter opening with rigid plastic and use something with weight to hold it down and vacuum again at the heater input.

This will help draw water out of any lines connected to the spa pack, especially for spas that do not have a circ pump.

WINTERIZING YOUR SPA

Cold climates, where danger of freezing exists, require special care on your part to prevent damage to the spa shell and equipment. If you plan to use your spa during the cold months, be sure your pump is running frequently enough to keep the water moving so that the heater will operate. It may be best to set your controls to always keep the pump on low speed. This will keep the water from freezing and the heater will come on as the temperatures drop.



WARNING:

If you have a power outage, and cold temperatures are possible, your spa and equipment could freeze, especially if it is mounted in a deck without a cabinet. Ice in the spa and equipment will cause damage.

You should consider the need to have your spa professionally winterized if it is to be dormant for a period. This is especially true if you are taking an extended winter vacation.

Follow the procedure below to help prevent damage to your spa and related equipment:

- 1) Drain the spa of all water, as outlined in owner's manual. Shut off the spa's power supply.
- 2) Remove any remaining water with sponge. If you have a shop vac, try vacuuming as much water as possible out of the jets and spa shell. If you cannot remove all the water (especially from the air injectors) RV style or plumbing system anti-freeze should be added to the injectors.
- 3) Remove spa equipment system and pump for storage inside. If this is not practical, use the shop vac again to draw any water from the pump(s) casings. Remove lower casing drain plugs. Add anti-freeze to all pump housings. (see note below)

When vacuuming spa lines:

- a) Vacuum at all suctions in the foot well. This could be 2-6 suctions depending on the model.
- b) Vacuum at the heater input (union and gate valve), usually on the left of the equipment side of the spa. Vacuum until you feel no more water coming out, then block the 2 cartridge mounts or block the Elite or Teleweir opening.

Remove the cartridge(s). Thread plugs into the threaded cartridge mounts in the filter box. For Elite or Teleweir filter system, remove the Vane weir/trim ring and float assembly. Cover the filter opening with rigid plastic and use something with weight to hold it down. Vacuum again at the heater input.

This will help draw water out of any lines connected to the spa pack, especially for spas that do not have a circ pump.

- 4) The filter should be drained, and cartridge removed and cleaned. Remove the filter cartridge and pour anti-freeze as mentioned earlier into the filter canister. Store the filter element in a room with above freezing temperatures.
- 5) Support the hard cover along the hinge with 2 by 4's across the spa. Lock your hard cover over the spa and cover entire spa with a tarpaulin. Block the tarp in place or staple to your cabinetry.
- 6) When you refill in the spring, remember to re-install any plugs that were removed. Follow the directions for start-up, as if this were a new spa.

Note: Any RV style or plumbing system anti-freeze used may leave behind a residue that could cause a white "fizz" in the first refill of water, especially when the jet pump(s) are turned on. You may need to drain and refill the spa to clear away the residue. **During colder months of the year, plumbing anti-freeze is added to all pump housings as part of our production procedures.** This fact is noted on the outer spa packaging.

TROUBLESHOOTING YOUR SPA

COMMON PROBLEMS AND HOW TO SOLVE THEM



NOTICE:

A large number of problems on start-up can be attributed to mis-wiring and a poor understanding of how the spa operates and its' features. Take the time to read and understand this manual. If you have any questions contact your dealer.

Ground Fault Circuit Interrupter (GFCI) or Residual Current Detector (RCD) Shuts Off On Initial Start-Up

Probable cause:	Mis-wiring of GFCI/RCD.
Action:	Contact electrician and/or dealer.

Ground Fault Circuit Interrupter (GFCI) or Residual Current Detector (RCD) Shuts Off (Not on Initial Start-Up)

Probable cause:	One or more pieces of equipment is shorting to ground or total current draw exceeds GFCI/RCD rating.
Action:	Contact dealer: DO NOT use spa. Take measures to ensure others do not use spa.

Spa is Completely “Dead” (No Circulation and No Display on Topside Control Panel)

Probable cause #1:	GFCI/RCD has tripped (shut off).
Action:	Reset GFCI/RCD and monitor for futures trips. Alert dealer if problem persists.

Probable cause #2:	Breaker or fuse before GFCI/RCD is tripped or blown.
Action:	Shut off GFCI/RCD, reset breaker or replace fuse, reset GFCI/RCD and test. Contact electrician or dealer if problem persists.

Probable cause #3:	Transformer fuse blown in spa pack.
Action:	Locate fuse in spa pack, test and/or replace. Or contact dealer for service.

Probable cause #4:	Insufficient line voltage to power up spa pack processor.
Action:	Contact electrician to measure line voltages and inspect supply connections.

No Heat or Heat Too Low

Probable cause #1:	Set point is not at desired level.
Action:	Review set point and change if necessary.
Probable cause #2:	Circ pump is not running or pumping.
Action:	Check if valves on circ pump/heater system are open (handle pulled up exposing valve shaft, safety clips should be in place to prevent valve closure). Check if circ pump is plugged in or if circ pump fuse in spa pack is burnt out.
Probable cause #3:	Spa is not covered when not being used.
Action:	Cover spa to retain heat.
Probable cause #4:	Heater is not on due to error message showing on display.
Action:	Check for open gate valves on equipment, correct low water level in spa, and examine condition of filter cartridge(s). Turn spa power off then back on. Monitor for reoccurring error message on display. Contact dealer if problem persists.
Probable cause #5:	System Input current setting is restricting heater operation.
Action:	Consult dealer/electrician on system current setup and if a higher input current is available from the supply. This may mean rewiring the spa with a larger gauge cable and/or breaker.
Probable cause #6:	Lack of insulation in a custom installation.
Action:	Protect underside of spa from prevailing cold winds or snow. Enclose custom installations.

Jet(s) Do Not Come On When Pump Key is Pressed

Probable cause #1:	Jet pump is not plugged into spa pack.
Action:	Plug pump in and test.
Probable cause #2:	Jet pump fuse blown in spa pack.
Action:	Locate & test/replace pump fuse in spa pack. Contact dealer if problem persists.
Probable cause #3:	Jet pump is not primed.
Action:	Shut off spa and allow trapped air to escape. Restart spa & check jet pump operation. If problem persists, bleed air at pump directly by opening union on pump until all entrapped air is released. Retest.

Probable cause #4:	Individually adjustable volume jets are adjusted to low volume.
Action:	Turn face of specific jet to increase water volume.
Probable cause #5:	Air control is closed. No visible air/water mix.
Action:	Open air control to increase air/water mix.
Probable cause #6:	Pump has overheated and tripped internal thermal overload.
Action:	Wait for pump to cool & listen for "snap" sound as overload resets. Pump should restart. Contact dealer if problem persists.
Probable cause #7:	Pump is not pumping due to broken part inside (motor works, pump is primed but there is no water movement from pump).
Action:	Contact dealer for service.

LED Light(s) Do Not Come On When Light Key is Pressed

Probable cause #1:	Light fuse blown in spa pack
Action:	Locate and test/replace light fuse in spa pack Call dealer if problem persists.
Probable cause #2:	In-line or on-board fuse blown in LED controller
Action:	Locate and test/replace light fuse in LED control box.

No Air/Water Mixture Coming From a Jet

Probable cause #1:	Air control is closed
Action:	Open air control
Probable cause #2:	Water volume through jet is too low to draw air
Action:	Increase water volume by turning jet face
Probable cause #3:	Adjustable jet internal is loose.
Action:	Tighten jet internal
Probable cause #4:	Jet internal is broken or damaged
Action:	Replace jet internal with another one from the spa or with a new one.
Probable cause #5:	Debris inside the jet internal
Action:	Remove the internal, inspect for debris, remove debris and re-install. Test

HOW TO CHECK A FUSE

Note: You should only remove/check a fuse if you feel comfortable doing so. **Do not risk personal injury. If in doubt, contact your service technician.**

Fuses are located within the wiring compartment. Always replace fuses with the same style and amp value as shown on the label inside the wiring compartment!

Small Glass Fuses

- 1) Shut off power to the spa.
- 2) Use a small screwdriver or pliers to gently remove the fuse from its fuse holder.
- 3) View the filament inside the fuse and replace if broken.
- 4) Use an ohmmeter to check the fuse. Ohms reading should be towards 0 ohms. A reading of infinity means the fuse is open and must be replaced.

Cartridge Fuses & Small Cartridge Fuses

- 1) Shut off power to the spa.
- 2) Use pliers to remove the fuse from its fuse holder.
- 3) Replace fuse and test system.

These types of fuses are available from your local dealer and may be available from local electronic stores and home centres. Each fuse has a voltage and amp rating listed on it and should be used to obtain a replacement fuse.

Note: A single fuse may protect more than 1 component in your spa.

WARRANTY SERVICE

In the event that you require warranty service, please call the authorized dealer where you purchased the spa. Your dealer has trained service personnel and an obligation to provide you with excellent after-sales service. We conduct yearly training classes to update and refresh technicians.

CONFIRMING A SERVICE APPOINTMENT

Have ready the serial number and model number/name of your spa, your date of purchase and store receipt. The spa model and serial number information can be found on the silver and black data plate attached to the lower right corner on the equipment side of the spa. It is also located on the Spa Identification Sheet that is within a plastic bag stapled to the backside of the equipment panel.

BP501X SERIES SPA PACKS – NORTH AMERICA

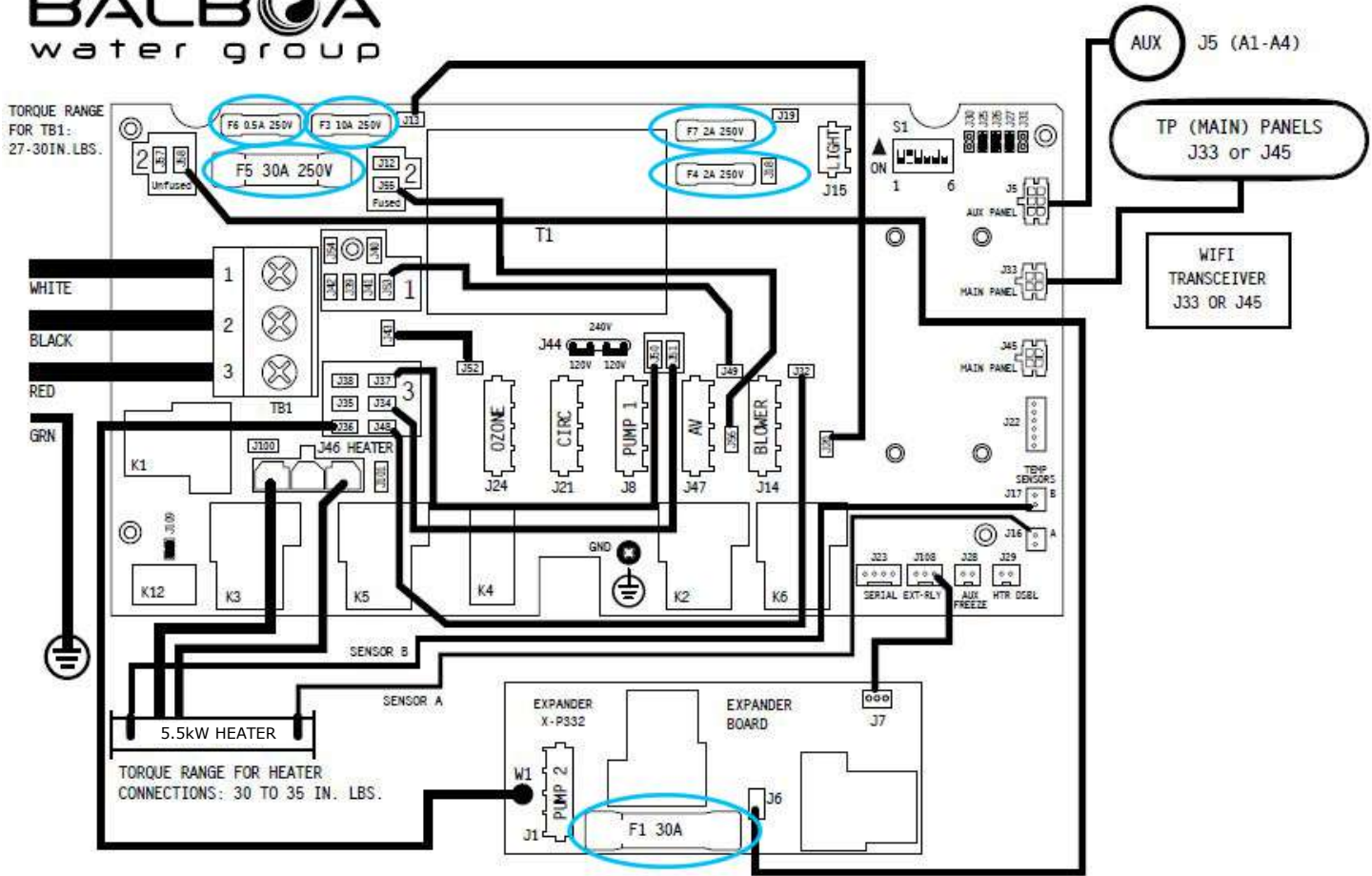

LOCATION	DEVICE	VOLTS	AMPS	FROM	TO	FROM	TO
J1 ON EXPANDER	2 SPD PUMP 2	240V	12A MAX	W1 ON EXPANDER	AREA 3	J6 ON EXPANDER	J58

“Typical Board Layout”

Fuse	Size	Protects
F1	30A, 250V	Pump 2 (Expanded Board)
F3	10A, 250V	Blower
F4	2A, 250V	Spa Light
F5	30A	Pump 1, Circ Pump, Ozone
F6	0.5A, 250V	Transformer Input
F7	2A, 250V	Transformer Input

BP2000X SERIES SPA PACKS

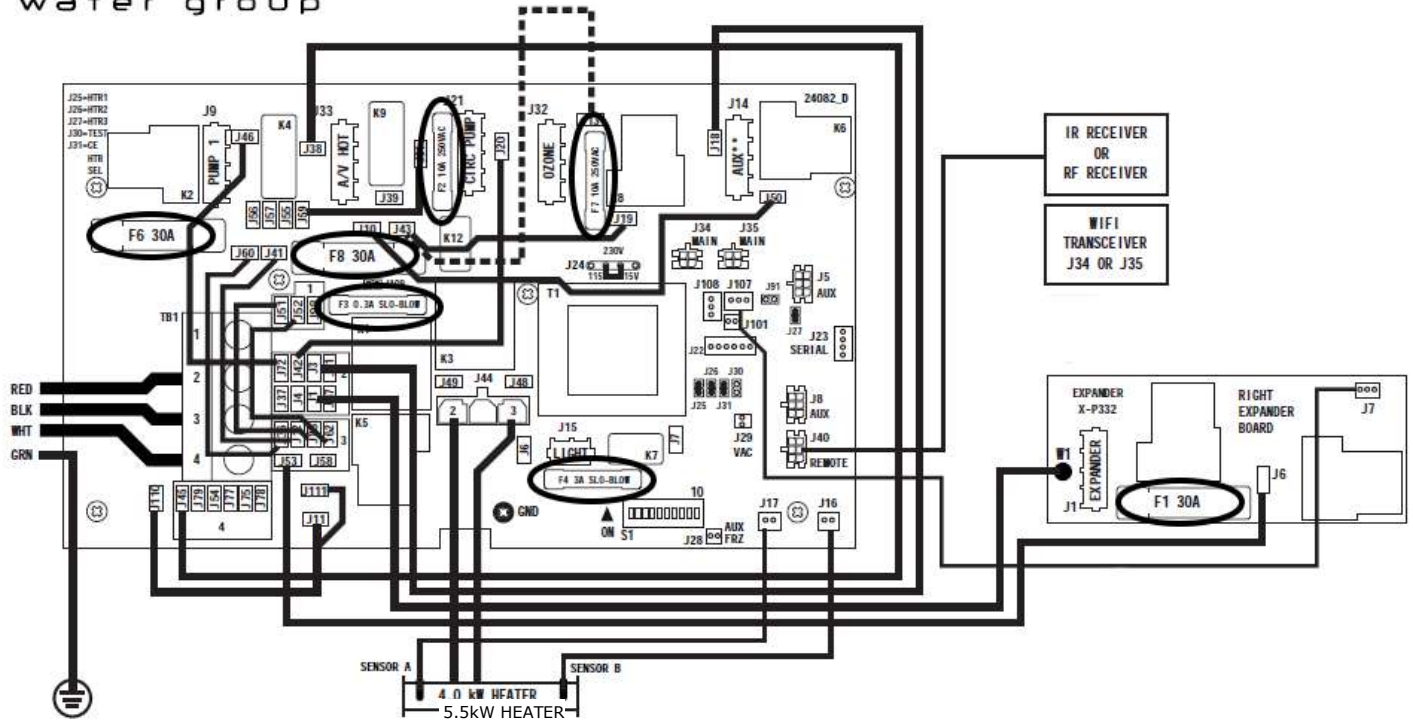

“Typical Board Layout”

Fuse	Size	Protects
F1	30A	Component(s) plugged into J1 on expander board Typically Pump 2, Pump 3, MicrosilK
F2	10A, 250VAC	Ozonator, Circ Pump
F3	0.3A, S10-B10	Transformer
F4	3A, S10-B10	Spa light
F6	30A	Pump 1, Audio
F7	10A, 250V	Blower (J14)
F8	30A	Pump 2, Blower (J14)

Note: When system software set-up is such that blower is connected to Expander X-P332, the inline fuse in the AMP adapter is 10A, 250V.

BP2100X SERIES SPA PACKS – EUROPE

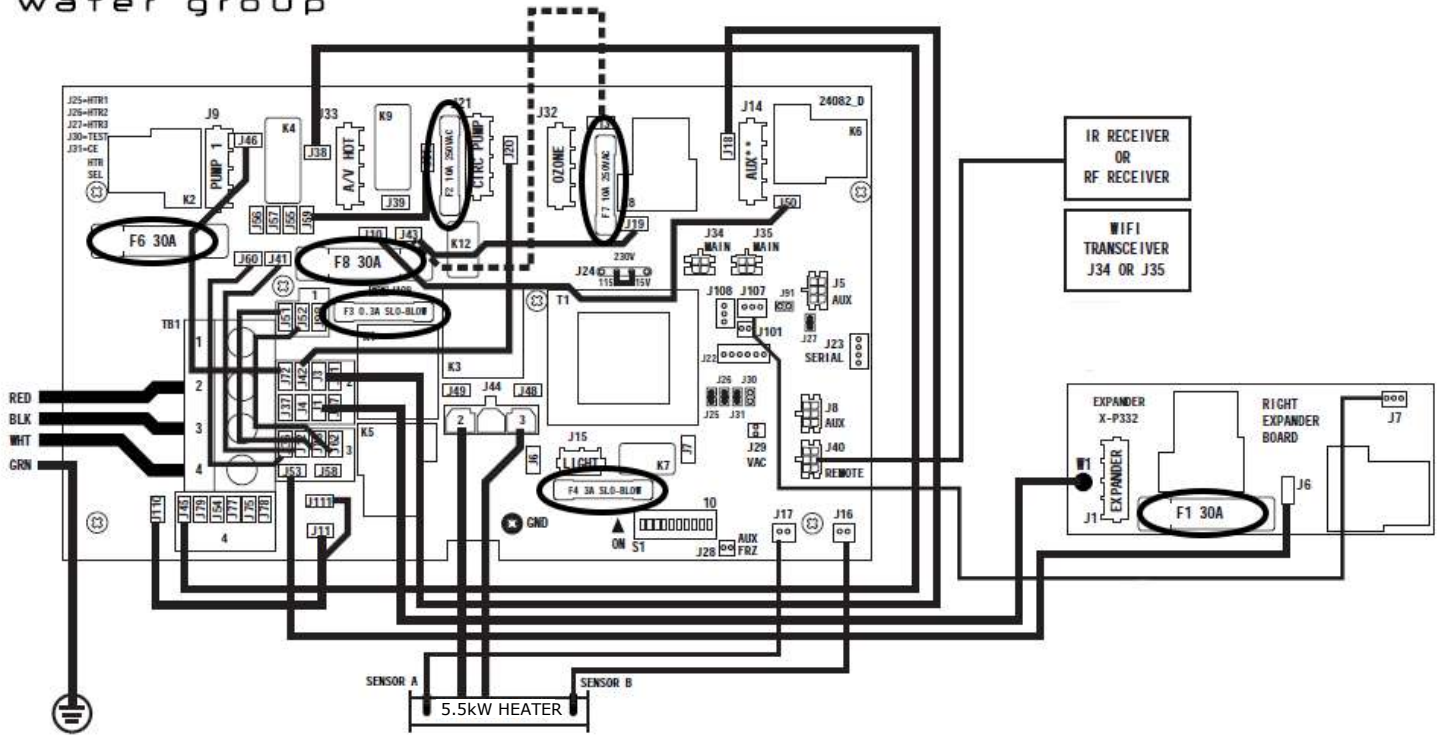

“Typical Board Layout”

Fuse	Size	Protects
F1	30A	Component(s) plugged into J1 on expander board Typically Pump 2, Pump 3, Microsilks
F2	10A, 250VAC	Ozonator, Circ Pump
F3	0.3A, S10-B10	Transformer
F4	3A, S10-B10	Spa light
F6	30A	Pump 1, Audio
F7	10A, 250V	Blower (J14)
F8	30A	Pump 2, Blower (J14)

Note: When system software set-up is such that blower is connected to Expander X-P332, the inline fuse in the AMP adapter is 10A, 250V.

WATER TREATMENT GUIDE



HEALTH HAZARD:

The water in your spa must be chemically treated and maintained at regular intervals.



WARNING:

Under Health Canada Re-evaluation Decision RVD-2018-36 **Sodium Bromide Spa Products** are not to be used in combination with:

- An electrolysis device (for example, a chlorine generator)
- Ozonation
- UV

Bacteria can enter your spa water through the fill source, the bathers, and the environment. It is the responsibility of the spa owner to chemically treat the spa water in accordance with the local standards. Cross contamination between bathers can occur.

Your dealer or local pool and spa professional can provide expert testing along with all the products you will need for clean* spa water. Follow their instructions. Untreated water is not only uncomfortable to relax in; it poses a health hazard to all bathers and a safety hazard to the equipment. Equipment and surface damage caused by poor water treatment and/or unbalanced spa water is not covered under warranty.

MANAGING YOUR SPA WATER

IMPORTANT: * Your dealer may be promoting a water treatment system that does not employ part of all the general water care instructions below. This guide is designed to give the spa owner a basic understanding of spa water treatment. * When in doubt, follow the recommendations of your dealer. It is recommended that you have your source water tested by your dealer or local testing agency before the first fill. Knowing the characteristics of your source water can help you maintain clean* and clear spa water on a regular basis.

Do not allow any floating chemical dispenser to get drawn in and held in the skimming area. Large amounts of chemicals can become concentrated in one area and damage the acrylic surface. This type of damage is not covered under the warranty.

** Clean is defined as the removal of microscopic (to 30 µm level) debris from the water. Ozone aids in the grouping of small debris. Once combined, the debris can be more easily caught by the filtration process.*

Initial Start-Up

(Review chemical manual - if applicable)

Your spa has _____ litres, _____ gallons of water (please fill in).

1. When the spa is full, add a scale preventative to inhibit staining and scale formation.
2. Test and adjust alkalinity to level recommended by manufacturer, this stabilizes pH.
3. Circulate water for 24 hours.
4. Test the pH. The ideal range is 7.2 to 7.6. Adjust if necessary, with pH Booster or pH Reducer.

5. Circulate the water for 30 minutes.
6. If you are using Organic Bromine (Bromine Tablets), adjust your dispenser so the bromine residual is 3 to 5 ppm. Lower bromine level may be possible with ozonator.
7. Whenever adjusting spa chemicals, less is better. Add chemicals in small amounts over several days.

Does your spa have a Fresh Water Ozone system on it?

1. The Fresh Water Ozone System is very simple to monitor. Follow the procedures listed below to ensure continued clean* water.
2. Using chlorine and a DPD (diethyl-p-phenylenediamine) test kit, measure Free Available Chlorine (FAC) and Total Chlorine (TC). As long as the difference is less than 0.5 ppm, the oxidizer from the Fresh Water Ozone system is entering your spa and cleaning* your water.
3. Check your pH, total alkalinity and calcium hardness as recommended by your Sunrise Spa dealer and adjust if required. Please note: With the Sunrise Fresh Water Ozone system, maintain a pH between 7.6 and 7.8.
4. Check the bubble mist entering the spa, via the dedicated ozone/return jet, for consistency. An irregular bubble mist could indicate a blockage in the pump or pipes, a dirty cartridge(s), low water level or pump operation problems.
5. On an ultraviolet ozonator, check the glow fitting on the ozonator for a blue colour to ensure that the bulb is on. On a CD ozonator check that the 'power on' indicator light is on.
6. Disconnect the tubing from the glow fitting and place your finger over the end of the tubing to feel for suction. This will ensure that the bubble mist entering your spa is coming through the Sunrise Fresh Water Ozone system.

REMEMBER: Your spa water cannot be treated if the circulation system is not operating. The longer the spa's circulation system runs, the cleaner* your water will be. This is not a problem on spa with a dedicated circulation pump. However, on models that use the low speed of a 2-speed pump to circulate the water, the filter cycle should be no less than 4 to 6 hours per day.

** Clean is defined as the removal of microscopic (to 30 µm level) debris from the water. Ozone aids in the grouping of small debris. Once combined, the debris can be more easily caught by the filtration process.*

Daily Maintenance

To keep your spa water sparkling clear and odour free, follow these steps:



1. Spas with adjustable filter cycles should be operated a minimum of 8 hours a day to remove suspended particles that may exist. (4 hours per a 12 hour period)
2. Test pH to maintain a level of 7.2 to 7.6. If an ozonator is being used, pH should be 7.8 while ozonator is working.
3. If you are using Organic Bromine (Bromine Tablets) adjust your feeder so the bromine residual is 3 to 5 ppm.

Weekly Maintenance

When the spa is not in use:

1. Add 1 cap (30 mL) of a Scale Preventative per 250 gal (1000 Litres) to inhibit scaling and staining. Circulate water for 30 minutes.
2. Add a Brightener 24 hours after adding the Scale Preventative. Circulate the water for 30 minutes.
3. With the bromine sanitizing system, dirt and grit may build up during the week. The spa should be shocked to eliminate any odour and restore clarity to the water.

Periodic Maintenance

1. Greases, oils and organic waste can accumulate on the filter cartridge reducing their efficiency and limiting the effectiveness. Clean the filter with CARTRIDGE CLEANER as directed by the manufacturer. Physically clean the filter basket daily (if applicable).

NOTE: It is not recommended to use muriatic acid on filter cartridges as this is a raw chemical which does not rinse out well, ending up back in the water causing low pH levels.

2. The use of the scum reduction product will cut down on grease, foam, and suspended particles in the spa. The scum reducer acts as a filter before the filter and will increase the life of the cartridge.
3. The use of a thermal insulated hard cover will reduce evaporation and heat loss. Always keep cover on and level when spa is not in use.
4. Once you have established a comfortable water temperature to soak at, leave the thermostat at that temperature. Rapid changes in water temperature consume more energy.
5. Take a sample of water to your dealer to test for alkalinity, calcium, and total dissolved solids.
6. **WHEN TO DRAIN SPA WATER.** Due to the warm water temperature and high evaporation rate, the total dissolved solids tend to build up. For this reason, we recommend draining and refilling the spa every 2 to 4 months - depending on usage.
7. Clean your filter(s) at least once every two weeks or after heavy bather loads, by soaking your filter(s) in cartridge cleaner. Dirty filters cause the heater to shut off or the spa temperature to drift lower than desired.

NOTE: Remove any objects floating on the water before removing skimmer basket and filter or they may be sucked into the pump.

NOTE: Spas should not be left running unattended without filters. Remove filters for cleaning. Always turn off the spa before removing the cartridge(s) Debris can enter plumbing and cause damage.

CHEMICAL SAFETY TIPS

Read the Directions Carefully

1. Always add chemicals to water, never add water to chemicals.
2. Do not mix chemicals.
3. Store chemicals in a cool dry place - out of reach of children.
4. In case of contact or if chemical is swallowed, follow emergency advice on product label.
5. Do not smoke near chemicals. Keep the container closed when not in use.

Water Balance

Water balance is important to the overall performance of your spa. No 2 spa's water conditions are exactly alike. The water source, location of the spa and frequency of use all effect the water balance. Unbalanced water can damage the equipment, especially the heater element, make the water uncomfortable for the user, and decrease the effectiveness. Total alkalinity, pH, and calcium hardness must be within the correct range to balance the water. Damage to equipment caused by improper water chemistry is not covered by warranty.

pH

Simply pH is a scale indicating whether spa water is basic, neutral or acidic. Spa water should be slightly basic 7.2 to 7.6; 7.8 with an ozonator in operation. A low pH below 7.2 leads to corrosion of spa equipment and will irritate the skin of the bathers. The sanitizer will dissipate more rapidly. A low pH can be corrected by adding a pH Increaser.

Alkalinity

Total alkalinity is a measure of the alkaline level in the water. They act as a pH buffer or a pH stabilizer preventing large changes in the pH. The total alkalinity should be between 80 to 150 ppm; ideally 120 ppm. Tablet bromine tend to gradually lower the alkalinity level.

Low total alkalinity causes:

- the pH to wander
- corrosive water
- sanitizers to be less effective

To raise the total alkalinity, add ALKA RISE™.

High total alkalinity causes:

- cloudy water
- scale formation

To lower the total alkalinity, add a pH Reducer.

Calcium Hardness

Calcium hardness is the hardness present due to dissolved calcium. The desired range is 150 ppm to 280 ppm.

Low calcium hardness causes:

- corrosive water
- staining of spa

To correct this problem, add a Scale Preventative. (Do not fill the spa with soft water!)

Common Spa Water Problems

PROBLEM	POSSIBLE CAUSE	SOLUTION
CLOUDY WATER	<ul style="list-style-type: none"> a) Contaminant build up b) Suspended dirt and grit c) pH high d) Total Alkalinity too high e) Hardness too high f) Poor filtration g) High dissolved solids 	<ul style="list-style-type: none"> a) Shock treatment with a spa shock product b) Add a Brightener, use scum reducer c) Add pH reducer, until pH level reads 7.2 - 7.6 d) Add pH reducer, adjust total alkalinity to 80-150ppm e) Add a Scale Preventative, circulate through a water softener until hardness is 150-280ppm. f) Dirty filter, clean with Cartridge Cleaner g) Empty spa and refill
COLOURED WATER	<ul style="list-style-type: none"> a) Dissolved copper, iron and other metals from source water or equipment b) Algae c) Fragrance 	<ul style="list-style-type: none"> a) Use Scale Preventative, have your dealer check water balance b) Add an Algaecide c) Stop the use of fragrance
FOAMING	<ul style="list-style-type: none"> a) High concentration of oils and dirt/grit being agitated by jets b) Soft water 	<ul style="list-style-type: none"> a) Squirt Defoamer on foam; use the scum reducer or spa ball b) Add a Calcium Increaser until hardness is 150-280ppm.
SCALE DEPOSITS	High calcium level, high pH, high alkalinity	Drain partially, add a Scale Preventative to correct pH level to 7.2 - 7.6 and alkalinity to 80-150ppm.
ODOUR	High level of organics, combined bromine	Shock with a spa shock
EYE/SKIN IRRITATION	pH too low	Add a pH Booster until level is 7.2 - 7.6
NO SANITIZER READING	High concentration of organics using up sanitizers	Add sanitizers until levels are up to recommended range

