



SWIMLIFE
SWIMSPAS

This Is The Life.

2022 MODEL **SWIMSTREAM**

SERIES **SwimFit / SwimExpert**

INSTALLATION GUIDE

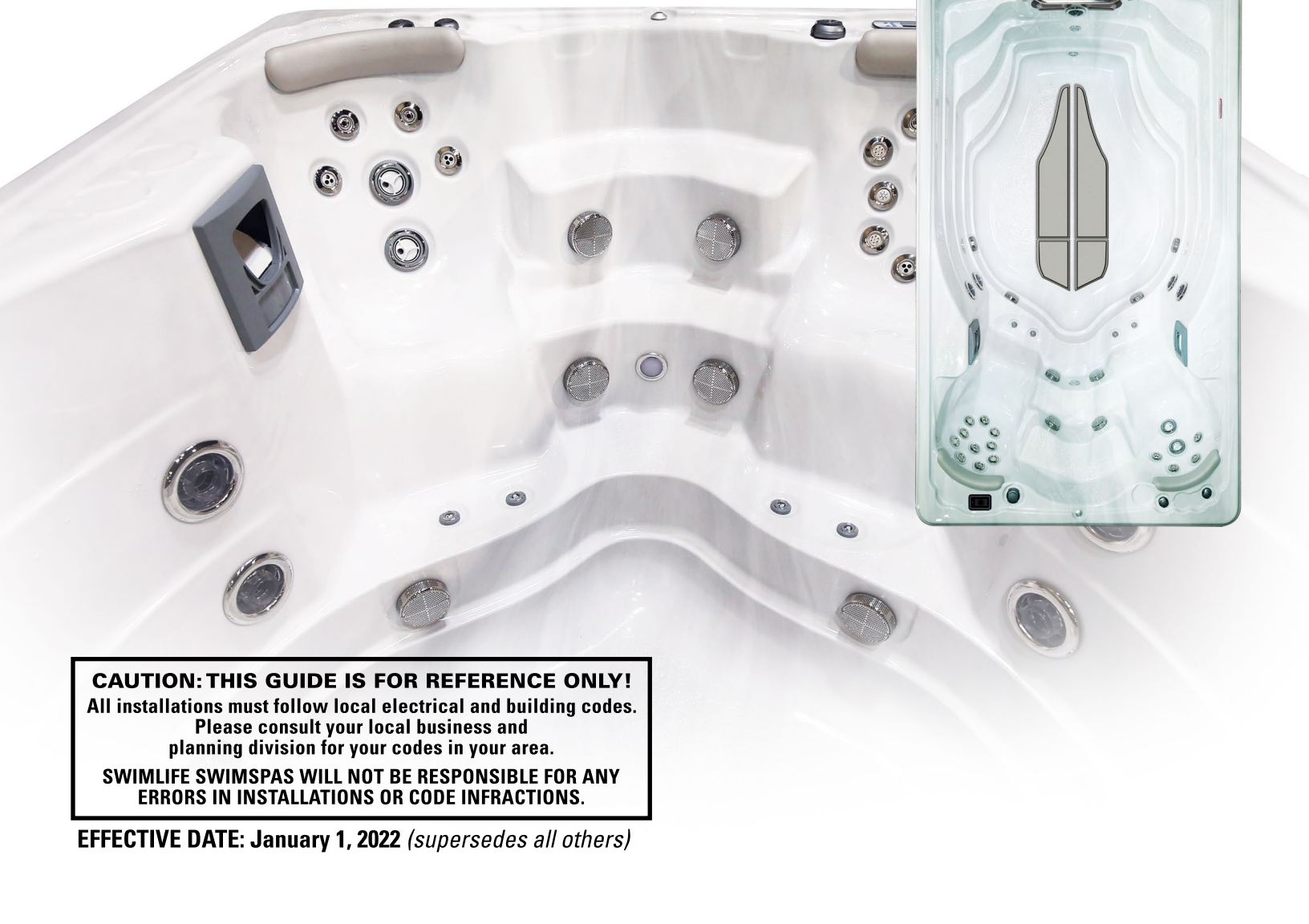

CAUTION: THIS GUIDE IS FOR REFERENCE ONLY!

All installations must follow local electrical and building codes.

Please consult your local business and
planning division for your codes in your area.

**SWIMLIFE SWIMSPAS WILL NOT BE RESPONSIBLE FOR ANY
ERRORS IN INSTALLATIONS OR CODE INFRACTIONS.**

EFFECTIVE DATE: January 1, 2022 *(supersedes all others)*

14ft. SwimFit / Expert SWIMSTREAM Installation Manual

TABLE OF CONTENTS:

| | | | |
|---|---------|--|------------|
| 1. Types of installs | Page 1 | | |
| 1.1 Free Standing with Cabinet above ground | | | |
| 1.2 Free Standing in Deck with or without cabinet | | | |
| 1.3 Below Grade Outdoor | | | |
| 1.4 Below Grade Indoor | | | |
| 2. Model, Specifications and Electrical | Page 2 | | |
| 2.1 Model and Series | | | |
| Shell Dimensions and Weights | | | |
| 2.2 Electrical Specifications | Page 3 | | |
| 2.3 Wiring Size | | | |
| 2.4 North American GFCI Installation | Page 4 | | |
| 2.5 European GFCI Installations | Page 5 | | |
| 3. Delivery and Handling Considerations | Page 6 | | |
| 3.1 Retailer Delivery | | | |
| 3.2 Direct Deliveries | | | |
| 3.3 Crane Deliveries | | | |
| 3.4 Fork Lift Deliveries | | | |
| 3.5 Roller Deliveries | | | |
| 3.6 Warnings | | | |
| 4. Above Grade | Page 7 | | |
| 4.1 Preparation | | | |
| 4.2 Concrete | | | |
| 4.3 Rooftop / Balcony Install | | | |
| 4.4 IMPORTANT: Swimspa Frame Shim Installation (Applies to All Installations) | | | |
| Cross Section Side View of 2022 14ft. SwimFit /SwimExpert Swimspa Install Inground | Page 8 | | |
| Cross Section Topside View of 2022 14ft. SwimFit /SwimExpert Swimspa Install Inground | Page 9 | | |
| 5. Below Grade or Partial In Grade Installations | Page 10 | | |
| 5.1 Backfilling Exclusion | | | |
| 5.2 Excavation | | | |
| 5.3 Vault/Bunker Specs | | | |
| 5.4 Base of Support | | | |
| 5.5 Crawl Space | | | |
| 5.6 Ground Water | | | |
| Cross Section Top View of 2022 14ft. SwimFit / SwimExpert Swimspa Inground... | Page 11 | | |
| Cross Section End View of 2022 14ft. SwimFit/ SwimExpert Swimspa Full & Partial Inground Installation | Page 12 | | |
| | | Cross Section Side View of 2022 14ft. SwimFit /SwimExpert Swimspa Install Inground | Page 13-14 |
| | | 5.7 Service Access | Page 15 |
| | | 5.8 Water Test | |
| | | 5.9 Overall Support | |
| | | 5.10 Insulation | |
| | | 5.11 Set Up and Assembly | |
| | | 5.12 Equipment Protection | Page 16 |
| | | 6. Serviceability, Accessibility and Protection | Page 17 |
| | | 6.1 Equipment Protection | |
| | | 6.2 Serviceability | |
| | | 6.3 Rodent Protection | |
| | | 7. Filling and Draining | Page 18 |
| | | 7.1 General Considerations | |
| | | 7.2 Indoor Installations | |
| | | 7.3 Outdoor Installations | |
| | | 8. Auxiliary Heating Options | |
| | | 8.1 Gas Heaters | |
| | | 8.2 Other Methods | |
| | | 8.3 Auxiliary By Pass | |
| | | 9. Ventilation, Humidity Control, Other Indoor Considerations | Page 19 |
| | | 9.1 Humidity Control | |
| | | 9.2 Ventilation | |
| | | 9.3 Hardcover | |
| | | 9.4 Floor Drainage | |
| | | 10. Hardcover Storage | Page 20 |
| | | 10.1 Hardcover | |
| | | 10.2 Cover Lifters | |
| | | 10.3 Pool Shed | |
| | | 11. By Laws and Disclaimer | Page 20 |
| | | 11.1 Building Code | |
| | | 11.2 Excavation | |
| | | 11.3 Recommendations | |
| | | 11.4 Professionals | |
| | | 11.5 Sunlight | |

1. Types of installations:

1.1 Free Standing with cabinet above ground

This installation refers to a swimspa that is placed on a concrete pad, above ground and with a SwimLife Cabinet. Can be adjacent to a deck or butted up to a deck.

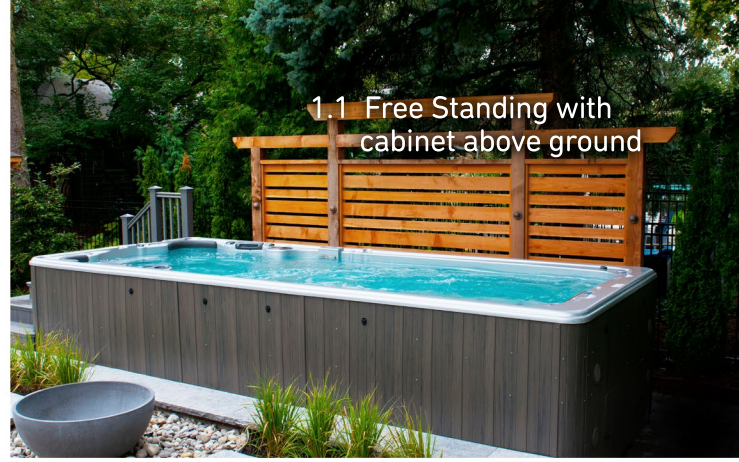

1.2 Free Standing in Deck

This installation refers to a swimspa that is placed on a concrete pad, above ground and with or without a SwimLife cabinet.

This Swimspa is surrounded on 1 or 2 sides by deck.



1.3 Below Grade Outdoor

This installation refers to a swimspa that is placed on a concrete pad, below grade and without a SwimLife Cabinet. Can be partially or fully recessed in the ground.



1.4 Below Grade Indoor

Indoor installations of a swimspa must be placed on a concrete pad. Swimspas can be partially or fully recessed in the floor.



2. Model Series, Specification and Electrical

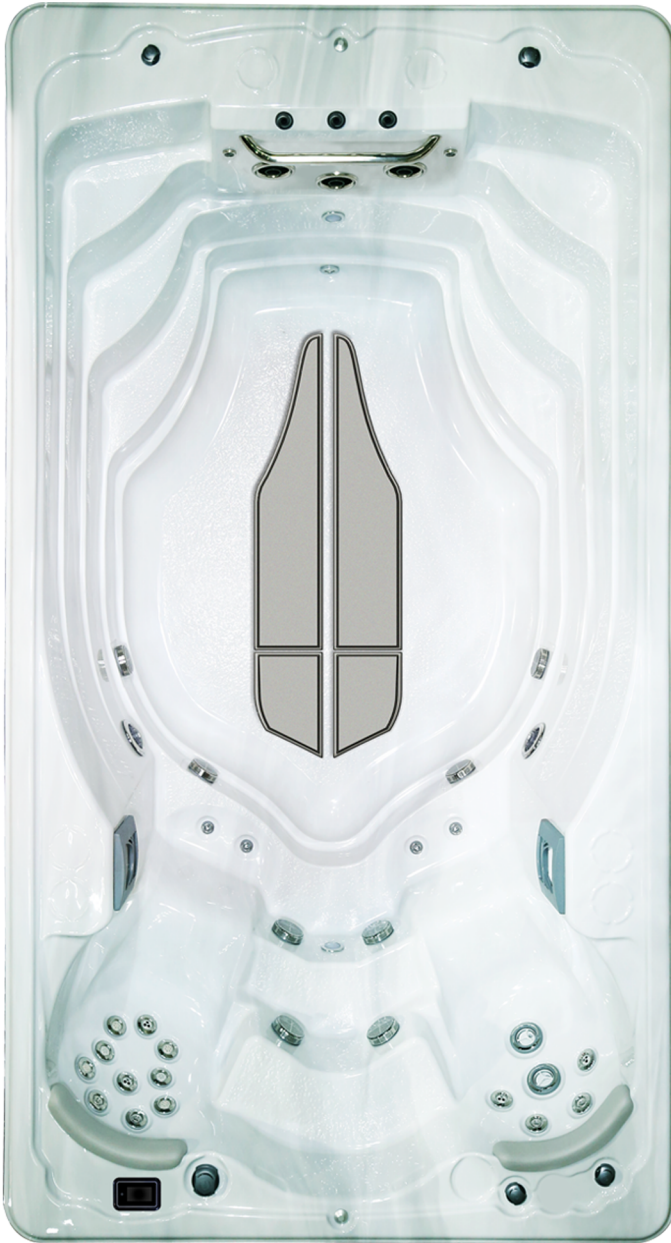

2.1
14ft.
SwimFit
SWIMSTREAM
SWIMSPA

Shell Dimensions:
174" x 93" /
441.96 cm x 236.22 cm
Height:
52.75" / 133.99 cm
Volume:
1,900 US gallons /
7,220 Litres
Weight Full:
18,445 lbs /
8,369 Kg
Weight Empty:
2,532 lbs /
1,149 Kg



2.1
14ft.
SwimExpert
SWIMSTREAM
SWIMSPA

Shell Dimensions:
174" x 93" /
441.96 cm x 236.22 cm
Height:
52.75" / 133.99 cm
Volume:
1,900 US gallons /
7,220 Litres
Weight Full:
18,445 lbs /
8,369 Kg
Weight Empty:
2,532 lbs /
1,149 Kg

2.2 Electrical Specifications

SAFETY COMES FIRST. WHEN INSTALLING & USING ELECTRICAL EQUIPMENT, BASIC SAFETY PRECAUTIONS MUST ALWAYS BE FOLLOWED!

1. READ AND FOLLOW ALL INSTRUCTIONS

- Electrical installation must be completed by a qualified electrician in accordance with all National, Regional and Local Codes and Regulations in effect at the time of installation.
- Connect only to a dedicated circuit protected by a class 'A' two-pole ground fault circuit interrupter (GFCI)

SwimLife highly recommends the use of a new Siemens GFCI breaker for all of its products.

4. Use copper conductors only!

- The Swimspa equipment and all electrical plugs, outlets and lights within 1.5m (5ft) of the unit must be G.F.C.I protected. Consult your electrician or local electrical authority for further details.
- A green colored terminal or a terminal marked "G", "GR", "Ground", or "Grounding" is located inside the supply terminal box or compartment. To reduce the risk of electric shock, this terminal must be connected to the grounding by means provided in the electric supply service panel with a continuous copper wire equivalent in size to the circuit conductors supplying the equipment.
- At least two lugs marked "**BONDING LUGS**" are provided on the external surface or on the inside of the supply terminal box or compartment. To reduce the risk of electric shock, connect the local common bonding grid in the area of the Swimspa to these terminals with an insulated or bare copper conductor not smaller than No.6 AWG (Canada/Europe) / No.8 AWG (USA).
- All field installed metal components such as rails, ladders, drains or other similar hardware within 3 m (10 ft) of the hot tub shall be bonded to the equipment grounding bus with copper conductors not smaller than No.6 AWG.

2.3 Wiring Size

NORTH AMERICA / EUROPE WIRE SIZE

Please consult your applicable electrical codes related to the size of the breakers and the wire. Take into consideration the length of the cable and increase as required.

G.F.C.I. / R.C.D. APPLICATION GUIDE FOR SWIMLIFE SWIMSPA SERIES

NORTH AMERICA

| | |
|-------------------------------|--------------------|
| SwimFun Swimspas | 50A |
| SwimFit Swimspas | 50A |
| SwimFit Dual Stream | 40A spa / 50A swim |
| SwimExpert Swimspas | 60A |
| SwimExpert Dual Stream | 40A spa / 60A swim |

EUROPE (single phase)

| | |
|-------------------------------|--------------------|
| SwimFun Swimspas | 40A |
| SwimFit Swimspas | 40A |
| SwimFit Dual Stream | 20A spa / 40A swim |
| SwimExpert Swimspas | 60A |
| SwimExpert Dual Stream | 40A spa / 60A swim |

IMPORTANT NOTE:

This guide is for standard installations where the wire run is 15m (50 ft.) or less. For longer wire runs, consult a qualified electrician.

2.4 North American GFCI Installation

Installation of the GFCI - Circuit Breaker, including ampere sizing and selection of conductor size and type, must be performed by a qualified electrician in accordance with the National Electrical Code, or the Canadian Electrical Code, and all Federal, State / Provincial and local codes and regulations in effect at the time of installation. SwimLife highly recommends the use of a new GFCI breaker for all of its products. Older GFCI's may have tripping issues.

NORTH AMERICA:

OPTION ONE:

SwimFit
240 V / 60 HZ / 50A

240 VOLT SINGLE PACK WIRING

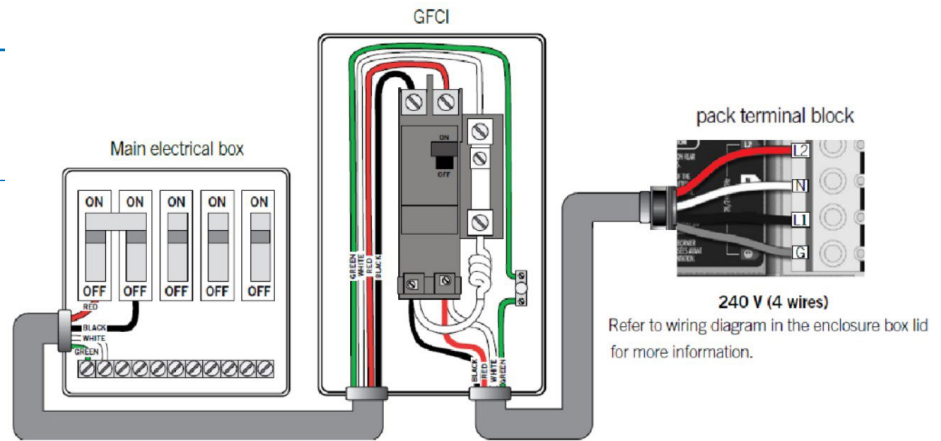

OPTION TWO:

SwimExpert
240 V / 60 HZ / 50A

240 VOLT TWO PACK WIRING

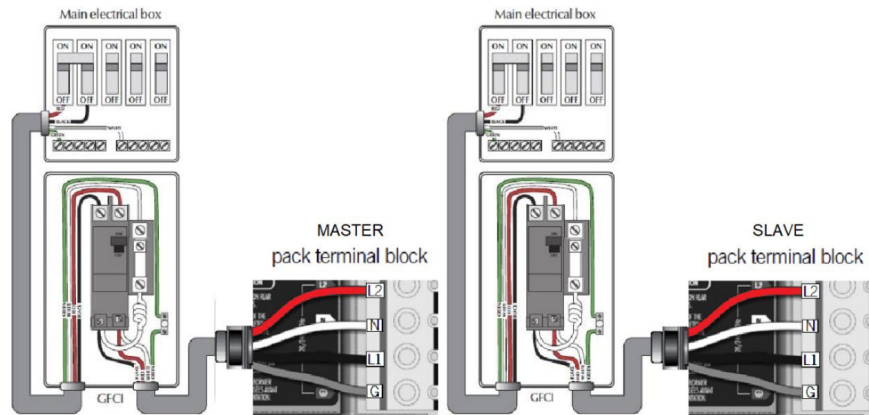

OPTION THREE:

SwimFit
(with Additional Optional Heater only)
240 V / 60 HZ / 60A

240 VOLT TWO PACK WIRING (ALTERNATE WIRING OPTION USING A DISTRIBUTION BLOCK)

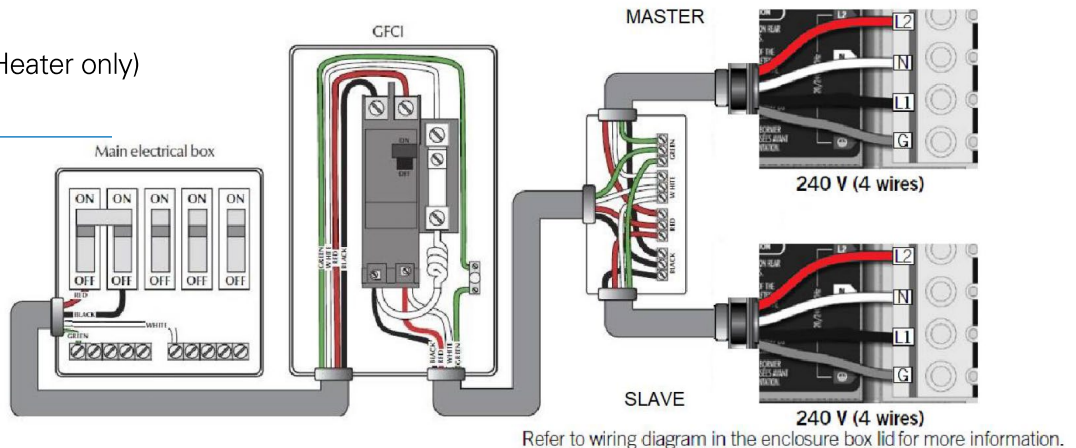

2.5 European R.C.D. Installation

Important Note:

Installation of the R.C.D. - Circuit Breaker, including ampere sizing, GFCI Security Breaker and selection of conductor size and type, must be performed by a qualified electrician in accordance with National, Regional and Local Codes and Regulations in effect at the time of installation.

EUROPE:

SwimFit 230 V / 50 HZ 40A

SwimExpert 230 V / 50 HZ 60A

230 VOLT 50 Hz SINGLE PHASE RCD WIRING (MASTER ONLY)

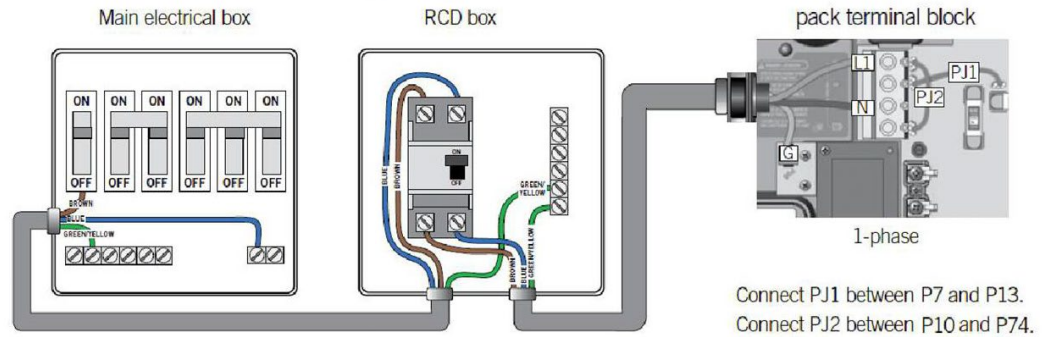

230 VOLT 50 Hz SINGLE PHASE RCD WIRING (DUAL SPA PACKS)

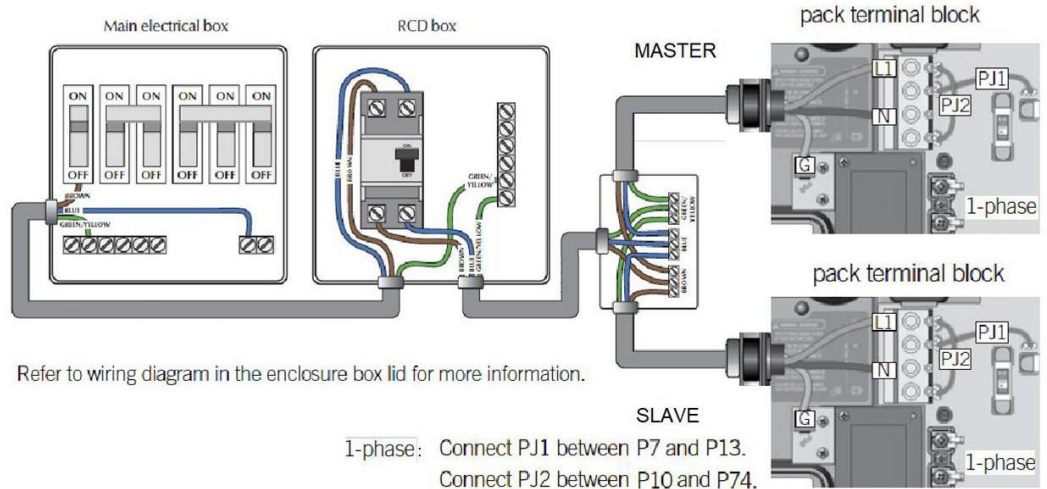

230 VOLT 50 Hz THREE PHASE RCD WIRING (DUAL SPA PACKS)

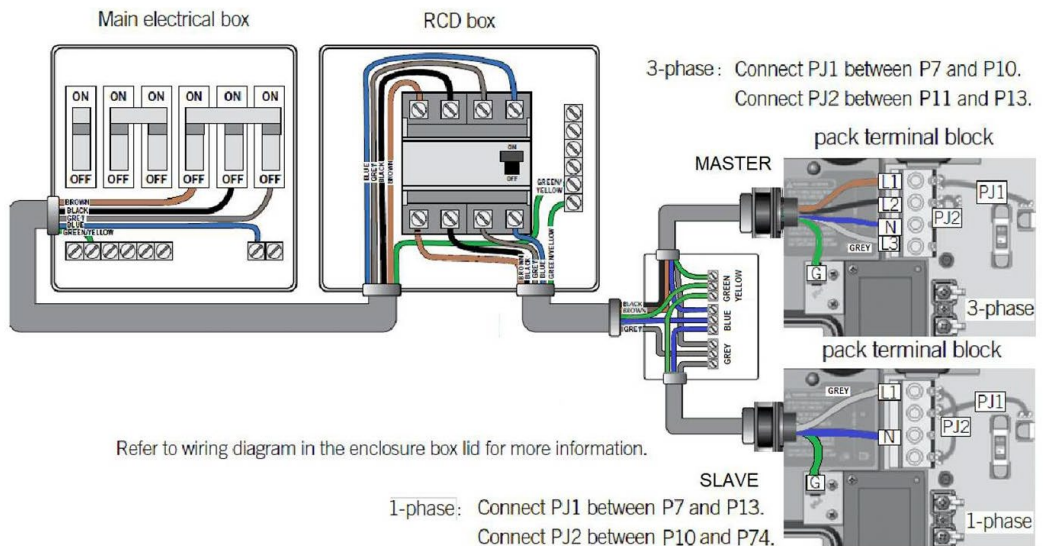

3 Delivery and Handling Considerations

3.1 Retailer Delivery

All SwimLife Swimspas are shipped with a layer of protective foam wrap, plastic film and cardboard for added protection. Each swimspa is shipped from the factory strapped onto a wood skid. If your swimspa is to be delivered by your local SwimLife retailer, it will generally arrive on a flat bed truck or low profile trailer. Typically, the dealer will arrive with the necessary equipment to maneuver the swimspa from the truck. The Swimspa can then be lifted by a crane into place.

3.2 Direct Deliveries

Like the retailer delivery, your swimspa will come wrapped and skidded the exact same way, however, your swimspa may arrive on a 48 ft. or 53 ft. common carrier closed box trailer. You can arrange the exchange at a local cross docking facility to a flatbed truck. The swimspa can then be lifted by a crane into place.

3.3 Crane Deliveries

Most installations require the use of a crane. When a crane is used for lifting, place the straps under the swimspa, ensuring that the plumbing lines and fittings are not stressed and / or damaged and a spreader is used. The straps should be secured so that they will not slip in any direction and strap spreaders utilized to prevent undue structural side load on the swimspa shell.

3.4 Fork Lift Deliveries

If you are removing the swimspa using a forklift, please make sure to use 8 – 10' / 2.5-3 m extended forks and pick up swimspa at the equipment end.

3.5 Roller Deliveries

Although it is recommended to install your swimspa by crane, it may be pushed along rollers by 10 to 12 able-bodied adults (see image).

If rollers are to be utilized, we recommend that at least six 4" / 10 cm diameter pipes, 8' / 2.5 m long, be placed under the shell to move it across a soft lawn, down a path, etc.

3.6 Warnings!

- Do not move or place the swimspa on its side
- Never lift or handle the swimspa by its plumbing
- the swimspas dry weight is in excess of 2,532 lbs. / 1,149 kgs.
- Please ensure lifting equipment is sufficient for the job. Manually lifting of the swimspa should be done with the proper manpower.
- We strongly recommend the installation to be done by a SwimLife Retailer.



4 Base Of Support – Load Specifications

4.1 Preparation

Installation of a level concrete pad is mandatory.

Dig out and level the ground 20 - 30 cm (8 -12 in.) below your desired base level. Install 20 -25 cm (8-10 in.) of crushed stone. If there is a possibility that the pad could shift by freezing / thawing ground movement (such as in clay regions, and / or areas with high water tables) concrete footings extending below the frost line are recommended.

4.2 Concrete

Install 10-15 cm (4 - 6 in.) of poured concrete. The concrete support slab must be flat and level in-order to properly level the hot tub during installation. The concrete pad should be slightly larger than the dimensions for the hot tub, but it may be expanded even further for esthetic purposes or to allow more space for walking around the hot tub. Ensure that your concrete pad is capable of supporting 1500 kg/m² (250 lbs. / ft²). If the hot tub is purchased with steps your concrete pad should be made large enough to accommodate the size of the step.

4.3 Second Level / Balcony Installation

You must know the load tolerance and compare it to the weight of the hot tub filled with water and people. When in doubt, a load distribution assessment carried out by an engineer should be consulted, who can guarantee the best location choice. Ensure that your second level balcony is capable of supporting 1500 kg/m² (250 lbs. / ft²). While swimming, the motors and water flow in all hot tubs generate vibrations that are directly transferred to the base on which the hot tub is installed. These can therefore be felt in lower levels. In this case, the support area must be properly engineered. Install a floor drain in the event there are any problems with the plumbing to sure that this water has a place to drain.

4.4 IMPORTANT: Hot Tub Frame Shim Installation (Applies to All Installations)

It is mandatory to have full support on all the gussets that are located on side of the hot tub to keep it level and prevent bowing of the hot tub shell. Always make sure that the slab is perfectly flat before having the hot tub installed. You can use a garden hose and spray water on the slab and look for water puddles. If there is formation of puddles, you must re-work the surface, by adding self-leveling concrete or by buffing down the un-even area. The tolerance for the shim under the gusset is 1/8". Anything greater than that may cause structural issues. When the hot tub is installed on the slab locate the stickers or white lines on bottom of the hot tub frame to determine where to install the shim. The shims must be installed right under the gussets (the sticker or white line will appear in the center of the gusset, so it can be used as a guide to align the shim. **Note:** There are 2 to 4 gussets per side depending on the model.

Simply attempt to insert the shim under the frame by hand and then gently tap on it with a hammer to make sure that it is secure under the frame. If the shim will not slide under by hand then no shim is need under that gusset. Proceed to the next gusset and repeat this process.

Then with a utility knife cut the shim flush to the end of the frame. When all the gussets are sitting properly on the ground, you can start filling the hot tub. Every hot tub will be delivered with a package of shims in case they are needed.

PLEASE NOTE: You may not require any shim, if your slab is perfectly flat. If the frame make perfect contact with the ground, you don't need to add the shim.



Cross Section Side View of 2022 14ft. SwimFit / SwimExpert SWIMSTREAM Install Above Ground

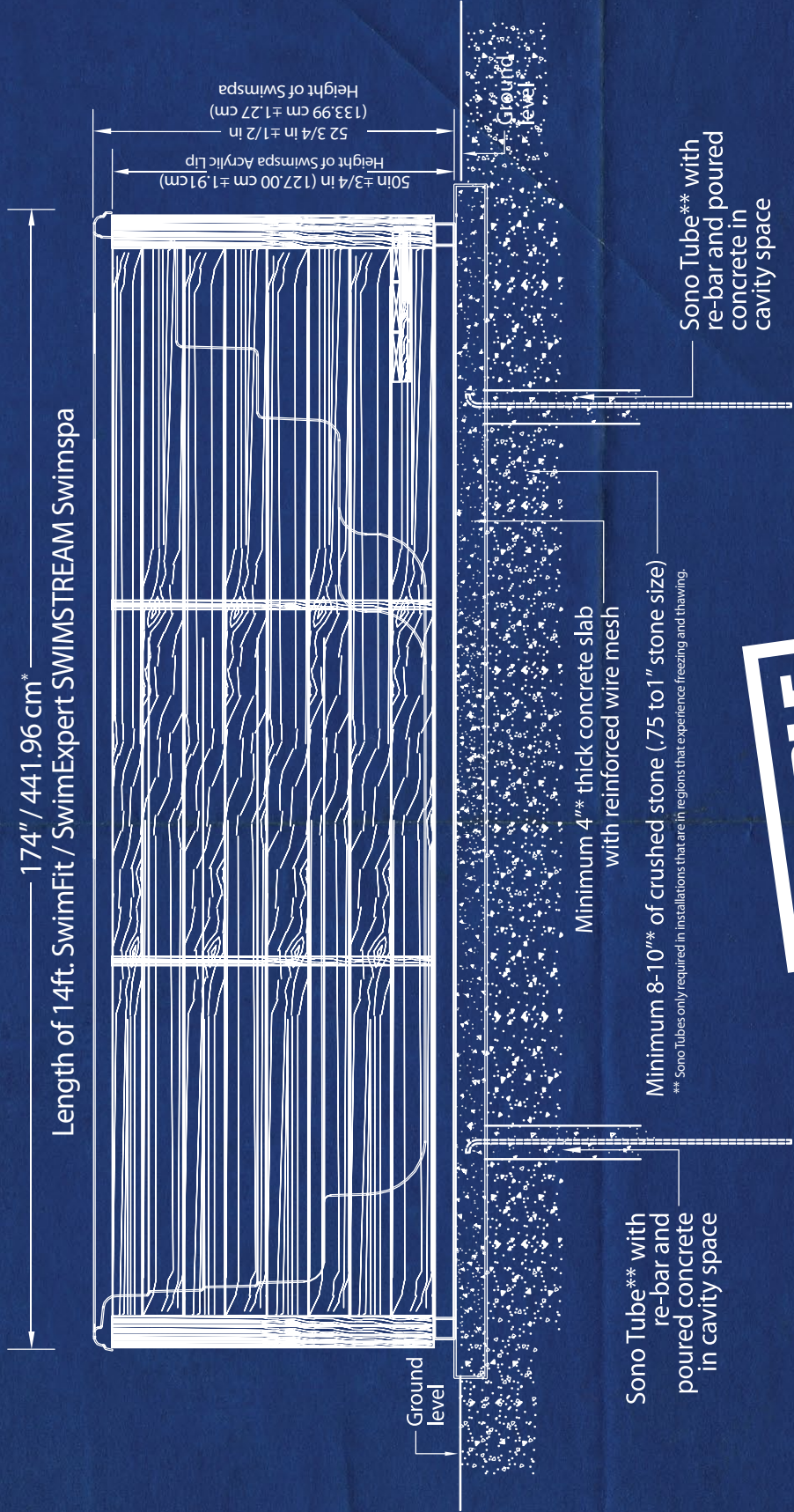

SAMPLE

* SwimLife Swimspas, can not be held liable for the accuracy of this drawing, it is purely provided as a guide only. As each swimspa installation has its own set of challenges and variations due to materials used and location of the install.

Cross Section Topside View of the 2022 14ft. SwimFit / SwimExpert Swimspa Install Above Ground

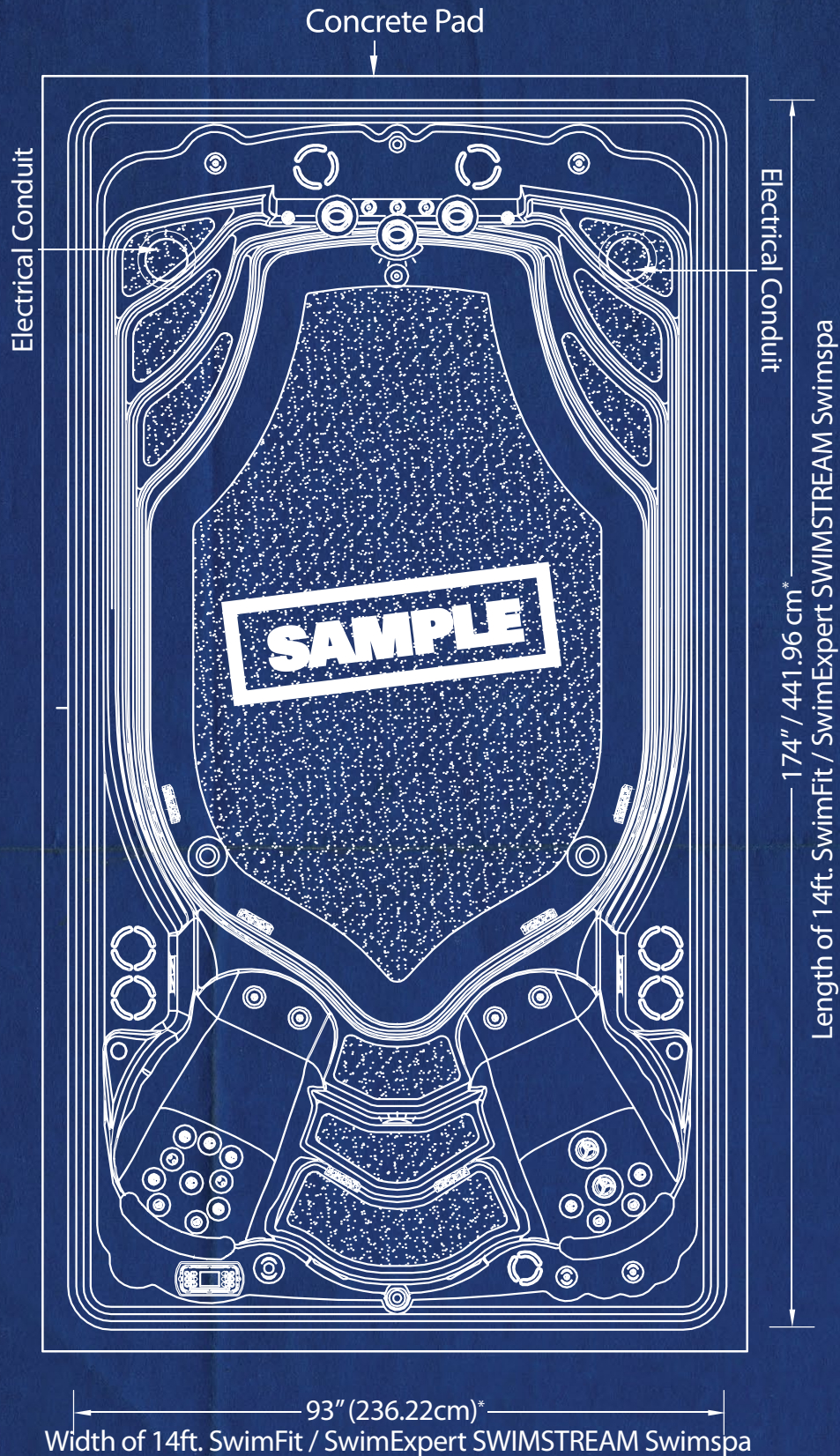

* SwimLife Swimspas., can not be held liable for the accuracy of this drawing, it is purely provided as a guide only. As each swimspa installation has its own set of challenges and variations due to materials used and location of the install.

5 Below Grade or Partial In Grade Installations Cabinet with Solid State Frame

5.1 Backfilling Exclusion

SwimLife Swimspas will void any warranty of swimspas that are back-filled.

5.2 Excavation

Call before you dig! Please make sure you have any permits in place that are required from your municipality.

5.3 Vault/Bunker Specifications

When recessing the swimspa all or part way below ground level, a concrete base along with a concrete retaining wall to hold back the earth is required. This forms a Vault or 'bunker', in which the swimspa is placed.

5.4 Base of Support

It is necessary that a concrete base be poured level and reinforced in order to support the swimspa. In addition, if you are in an area that experiences freezing and thawing concrete footings should be added as outlined in section 4 of this guide.

5.5 Crawl Space

It is recommended leaving a 24 in. (61 cm) wide crawl-space around the entire unit to ensure adequate accessibility on the all sides for service access. At the Equipment end it is recommended to have a 3 ft. / 90 cm crawl space for work space.

5.6 Ground Water

The Vault will be the lowest part of your backyard and therefore good drainage is essential. A properly designed drain system and sump pump complete with a float switch should be constructed as part of the crib and should be located at the equipment end of the Swimspa. This should prevent flood damage from ground water that may enter the crib.



Cross Section Top View of 2022 14ft.SwimFit / SwimExpert SWIMSTREAM Swimspa With Cabinet Installed Inground...

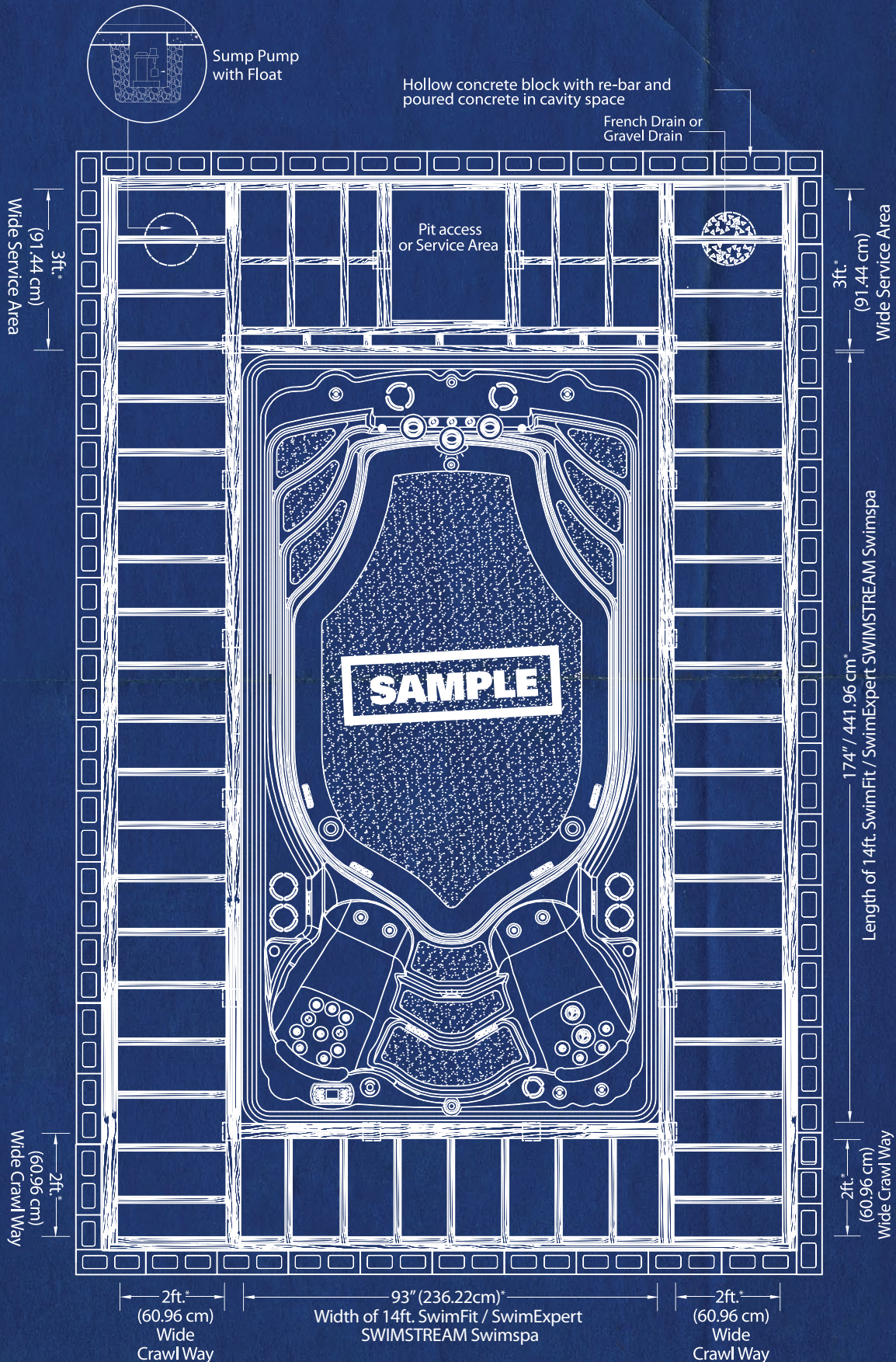

* SwimLife Swimspas, can not be held liable for the accuracy of this drawing, it is purely provided as a guide only. As each swimspa installation has it own set of challenges and variations due to materials used and location of the install.

Cross Section End View of 2022 14ft. SwimFit / SwimExpert SWIMSTREAM Swimsa With Cabinet Full Inground Installation...

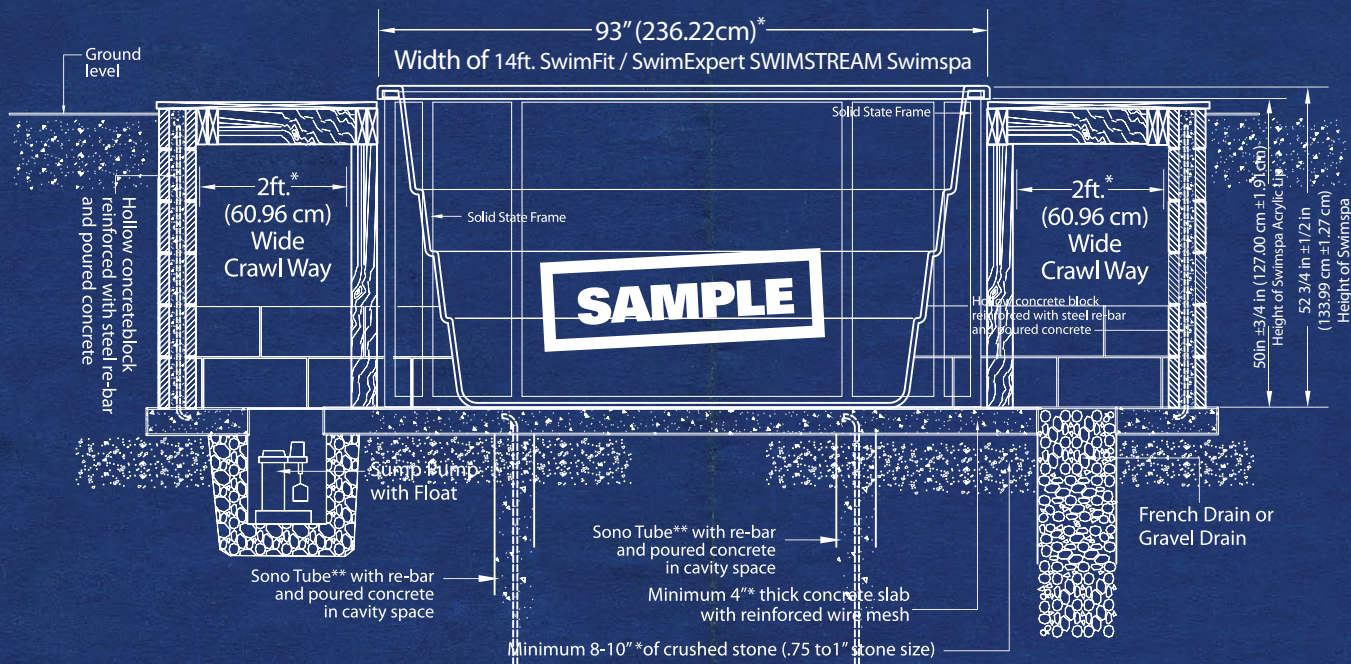

Cross Section End View of 2022 14ft. SwimFit / SwimExpert SWIMSTREAM Swimsa With Cabinet Partial Inground Installation...

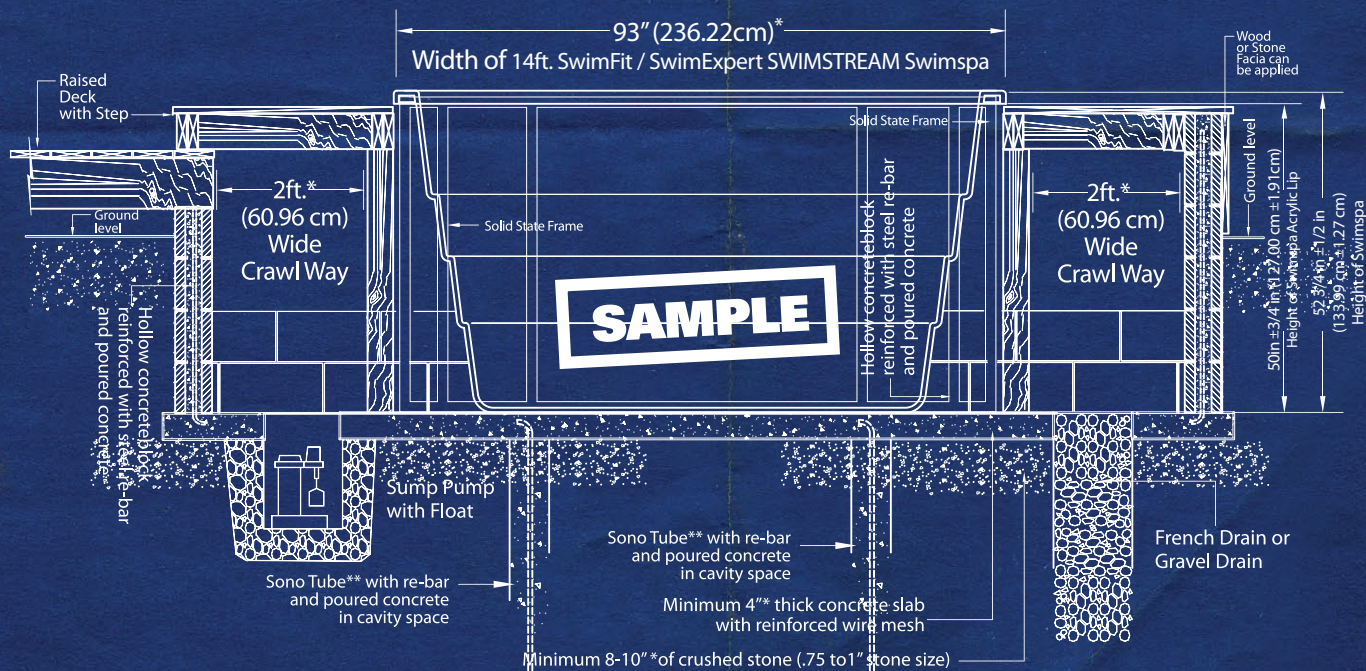

* SwimLife Swimsas, can not be held liable for the accuracy of this drawing, it is purely provided as a guide only. As each swimsa installation has its own set of challenges and variations due to materials used and location of the install.

Cross Section Side View of 2022 14ft. SwimFit / Swim Expert SWIM STREAM Swimsipa With Cabinet Install Inground...

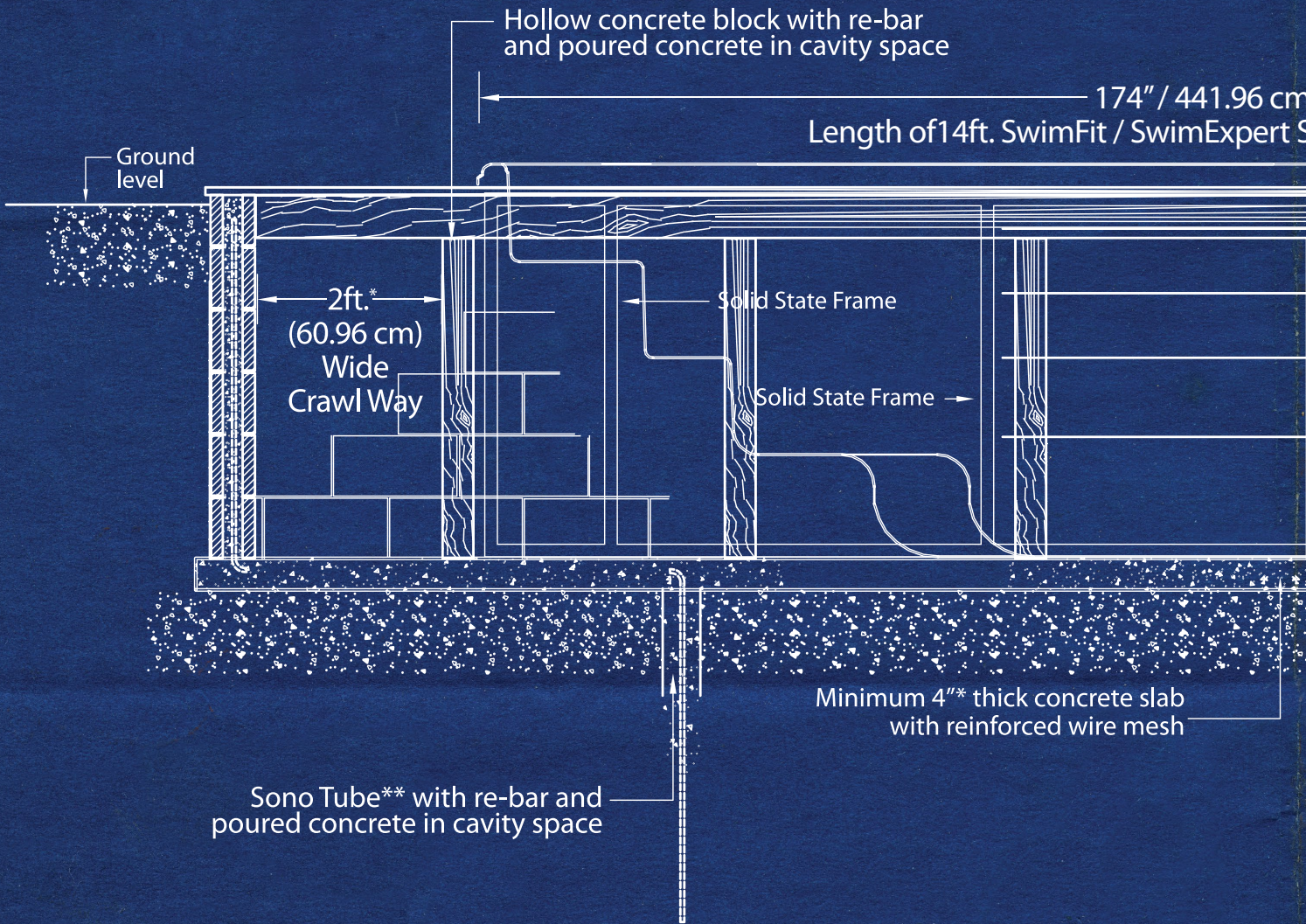

Notes: _____

SAMPLE

NOTE:
Support posts for the Access Hatch sit between the French Drain and Sump Pump

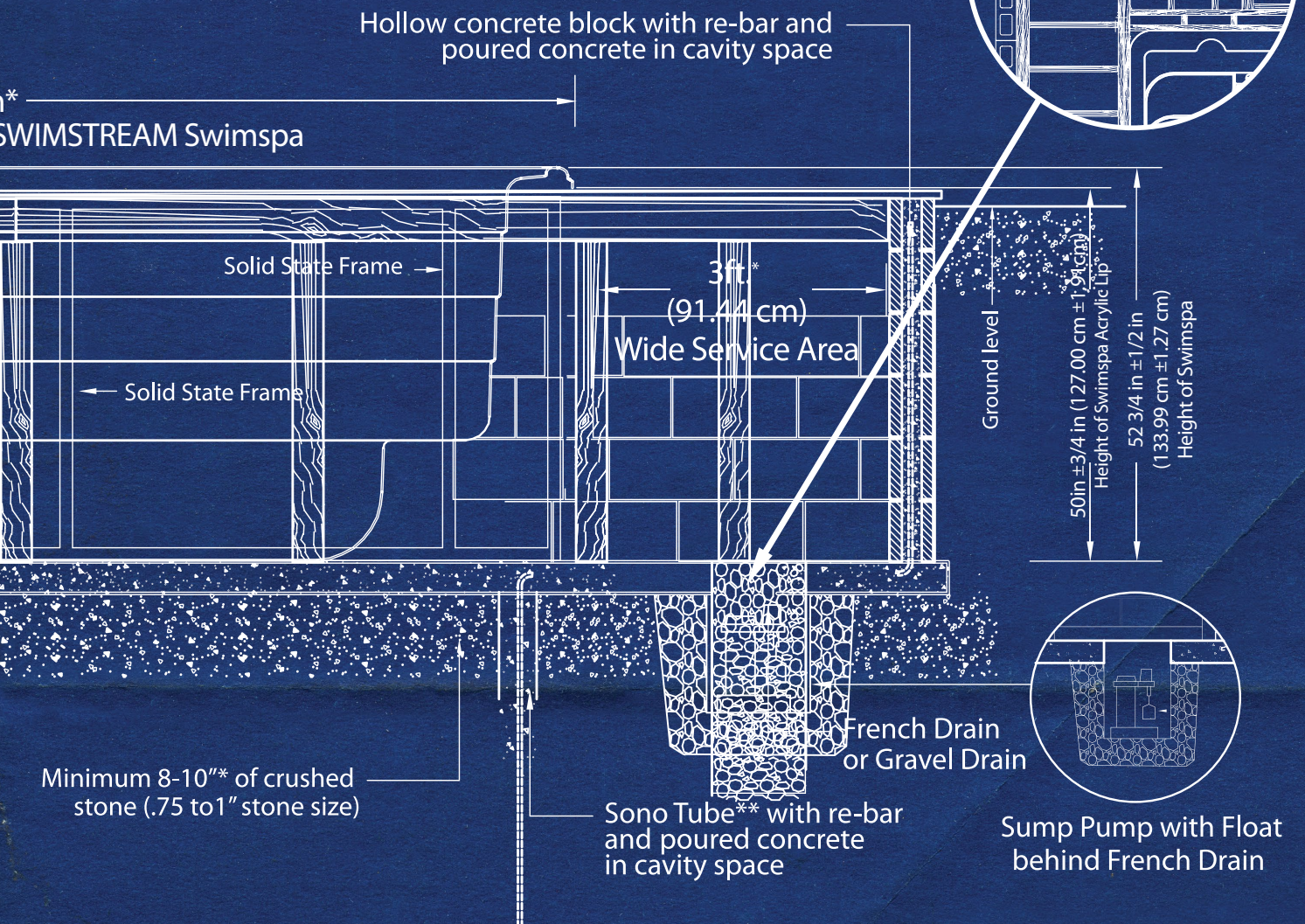

* SwimLife Swimspas, can not be held liable for the accuracy of this drawing, it is purely provided as a guide only. As each swimspa installation has it own set of challenges and variations due to materials used and location of the install.

Notes: _____

5 Below Grade or Partial In Grade Installations Cabinet with Solid State Frame (Cont'd...)

5.7 Service Access

Future service must be considered at the time of design and installation. You must be able to access all sides and areas of your swimspa. Difficult access will result in supplemental service labour charges not covered by the factory warranty. Consider easily removable deck materials.

5.8 Water Test

During shipping and handling some of the components may have shifted. Please ensure the swimspa is tested for 48 hours before you prepare the installation of the surrounding / finish deck around your swimspa. Even though all units are tested in our plant, some transport/site handling damage may occur and we suggest you make sure the swimspa is perfectly waterproof before finalizing your installation.

5.9 Overall Support

Your SwimLife Swimspa is equipped with a factory installed load support substructure, which distributes the weight of the water over the entire foot print area of the swimspa. The supporting floor must be even and level. Although the lip of the swimspa must be supported to ensure it remains level, **NEVER SUSPEND** a swimspa from a deck or floor by the outer acrylic edge, as this will lead to product damage and / or serious personal injury.

5.10 Insulation

It is important to create a well-insulated vault when installing a swimspa in ground. This can be done a couple of ways:

- 1) Use insulated concrete forms when pouring the walls of the vault. This will accomplish two things, one it will provide the wall support needed to build a deck and two it will give the insulation required to keep the running costs to a minimum.
- 2) After installing the concrete block for the walls of the vault, add Styrofoam Blue insulation or Thermal Shield blanket to the interior walls to create well insulated area.

5.11 Set Up and Assembly

Set-up of your swimspa will vary depending on whether you have purchased a SwimFit or SwimExpert model. Once your swimspa is set into place, you can adjust the posts for levelling the swimspa and the equipment is already connected.

5.12 Equipment Protection

The equipment must be located in an area where it will remain dry and will not be exposed to rain, snow or ground water. When your swimspa is to be installed above ground, the factory cabinet is designed for both protection, insulation and accessibility. When your swimspa is to be installed fully or partially in the ground, or if you have ordered a swimspa without a cabinet: it is necessary that the equipment be installed in an area that is dry, protected from the elements, has proper ventilation, and is easily accessible for service.



6 Serviceability, Accessibility and Protection

6.1 Equipment Protection

The equipment must be located in an area where it will remain dry and will not be exposed to rain, snow or ground water. When your swimspa is to be installed above ground, the factory cabinet is designed for both protection, insulation and accessibility.

When your swimspa is to be installed fully or partially in the ground, or if you have ordered a swimspa without a cabinet, it is necessary that the equipment be installed in an area that is dry, protected from the elements, has proper ventilation, and is easily accessible for service.

6.2 Serviceability

Ensure that access to the equipment, and the working area around the equipment, is large enough to accommodate a service person.

6.3 Rodent Protection

For any installation, protection from rodent infestation is imperative. If the swimspa is being installed with a cabinet, as long as your concrete pad is level there should be no need for any further protection against rodents. However, if the swimspa is being installed in ground without a cabinet it is important to take the precautions required to make sure rodents don't make a home in your vault area. Protect access points and repair if needed.



7 Filling and Draining

7.1 General Considerations

- Be sure to check with your local by-laws regarding disposal of waste water from your swimspa.
- Avoid filling with soft or well water.
- Filling through the skimmer is optimal for reducing / eliminating any air locks.

7.2 Indoor installations

There will be water lost in the swimspa due to splash out, hence, you will need to top up the swimspas periodically. When building the room for the swimspa consider plumbing a water tap location nearby to facilitate filling. You will need to drain your swimspa periodically, so please make sure to install a drain in the room that can handle the volume of water in a swimspa.

7.3 Outdoor Installations

Draining and Filling is easy with an outdoor swimspa. Use a garden hose to fill the swimspa and use the hose provided to drain it. Do not plumb a permanent fill or drain line to the swimspa if you are in an area where the temperature drops below freezing.

8 Auxiliary Heating Options

8.1 Gas Heaters

There are a number of different ways to heat your swimspa using the Auxiliary Heating Option, the most common is using a gas heater. The most common size used for our swimspas is 100,000 BTU / 30 KWH .

8.2 Other methods are Propane Heaters, Geothermal Heating and Solar heating.

Please consult your local retailer for more information on these alternative methods to heat your swimspa.

8.3 Auxiliary Bypass Option

Installing the SwimLife option Auxiliary Bypass can help to facilitate any of the above installation options.





9 Humidity-Ventilation Other Indoor Considerations

9.1 Humidity

All spas emit quantities of moisture into the surrounding air. In fact, evaporation will increase proportionally with the difference between the temperature of the surrounding air and of the water. To prevent this from happening, heat the air to more than 26° C / 79F if the spa is located inside a dedicated room. This will make bathing more comfortable and will limit evaporation.

9.2 Ventilation

The Spa room should have a window, and a humidistat controlled exhaust fan for ventilation. Some rooms may require a mechanical air extraction system in order to potentially dehumidify the air during and after swimming. Consult your local Building Codes.

9.3 Covers

If you decide to purchase the hardcover put it on when you are not using the spa. This will reduce evaporation and limit your water heating costs. Use your hard cover as much as possible or purchase a floating summer cover for easier use.

9.4 Floor Drainage

It is very important to install a non-slip surface / tile for your indoor installation as the floors will become very slick with water on it. It is also important to install floor drains around the spa to help with the splashout.



10 Hardcover Storage

10.1 Hardcover

If your Swimspa comes with a Hardcover, make sure to prepare storage area for when the Swimspa is being used. The Swimspa cover comes standard in a number of sections that are velcroed together depending on the size.

10.2 Cover Lifters

If you order a 14ft. SWIMSTREAM Swimspa, CoverLifters are a great addition. The Swimspa must be ordered with 2 bi-fold covers from the factory for the lifter to work. Attached to both ends of the Swimspa, Cover lifters make it easy to get in and out of the Swimspa.

WARNING: If you install a CoverLifter on the end of the Swimspa, it will block entry to the step area.

10.3 Pool Shed

Storing the cover in a pool shed is the most common way to keep the cover safe and out of sight.

11 By Laws and Disclaimers

11.1 Building Code

Contact your local building code department to determine if a building permit is necessary and for information on applicable bylaws (distance from property lines, buildings, fencing requirements, etc.)

11.2 Excavation

Prior to any excavation contact your local gas, electric, and cable company to ensure that there are no underground lines.

11.3 Recommendations and Preparation Guidelines

This an integral part of your order, and it contains the recommendations and guidelines for preparing your work site. It is important that you take the time to carefully read this document in your capacity of Project Manager.

11.4 Professionals

Attention: You must enlist professionals to complete the preparation work, and provide a copy of this document to each of them. This work will be carried out under their sole responsibility. Furthermore, if you plan to use a delegated Project Manager, you must also provide him or her with this document, and we recommend that you ensure its proper care in order to guarantee compliance with the regulations. Of course, we are available to answer all of your questions regarding the installation of your swimspa. The specifications described in this document are intended for professionals and are for informational purposes only. The Project Manager must consider these specifications while performing the work in accordance with the regulations and standards for the specific model.

11.5 Sunlight

DO NOT leave the swimspa out in the sunlight for extended periods of time with no water. The cabinet may bend slightly if exposed to sunlight for extended periods of time or the acrylic may crack.



10.1 Hardcover

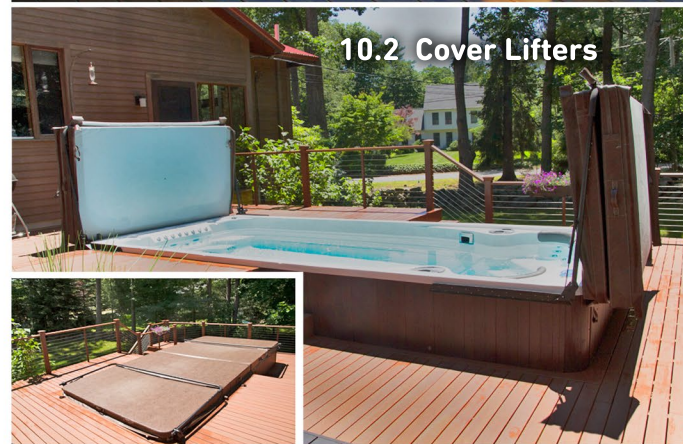

10.2 Cover Lifters



10.3 Trap Door

CAUTION: Covers must be kept on the Swimspa at all times when unit is drained or winterized. Direct exposure to sunlight can damage plastic parts and interior space, jets, or any interior components. Damage caused by exposure to sun will not be covered under warranty.



SWIMLIFE
SWIMSPAS
This Is The Life.

2022 MODEL **SWIMSTREAM**

SERIES **SwimFit / SwimExpert**

INSTALLATION GUIDE



CAUTION: THIS GUIDE IS FOR REFERENCE ONLY!
All installations must follow local electrical and building codes.
Please consult your local business and
planning division for your codes in your area.
**SWIMLIFE SWIMSPAS WILL NOT BE RESPONSIBLE FOR ANY
ERRORS IN INSTALLATIONS OR CODE INFRACTIONS.**

EFFECTIVE DATE: January 1, 2022 *(supersedes all others)*